

Process Plants



designed
to work perfectly

The Latest Process Technology from a Single Source

From a stand-alone mixer to a production plant

The innovative process plants are a logical extension of the IKA® machine portfolio. The core elements here are the tried and tested dispersing units.

IKA® specializes in plants for use in fully continuous processes. In addition to the dispersing of several liquids in a single pass, the proportional introduction of solids into liquids is an IKA® specialty. Conventional batch solutions complete the IKA® portfolio.

In addition to standard solutions, IKA® also designs and builds complete customer-specific process plants. We take into consideration all aspects that are important for successful and economical production; optimum process runs and customized controls, design that is easy to clean, project-based materials selection, explosion protection, and individual customer requirements.

The preference is for plants to be completely pre-assembled on frames and tested prior to delivery. This skid construction ensures rapid installation and commissioning on site, allowing production to begin as quickly as possible.



DIN EN ISO 9001



For more information, visit
www.ikaprocess.com



Made with IKA[®] Quality

The complete functional unit from a single source. Preinstalled, tested and ready for production in the shortest possible time.



IKA® Machines and Plants for Batch and Continuous Processes

1 > Mixing and Dispersing in a Batch Operation

The batch process is a discontinuous production process. Raw materials and energy are fed in and processed while the container contents are circulated. The finished product is manufactured in intervals.



Batch process with batch mixer

The result is determined by the time and the operating parameters of the equipment. To achieve the final product, the contents must repeatedly be recirculated in order to feed the product into the actual dispersing tool.

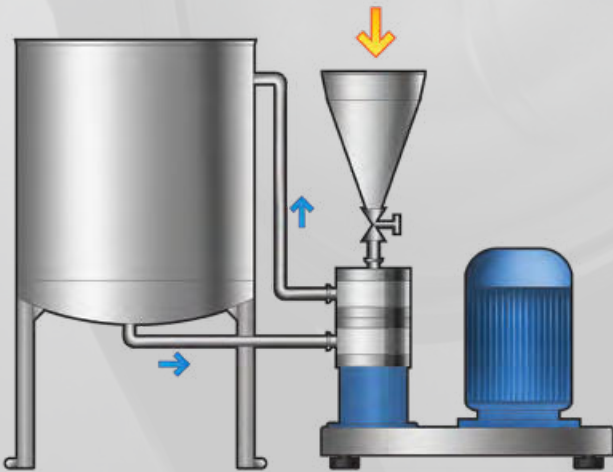

Batch process with an inline mixer in a recirculation process

The product quality is determined by the number of passes and the operating parameters of the machine. The actual mixing or dispersion process is carried out efficiently in small volumes..



2 > Mixing and Dispersing in Proportion to Quantity with Inline Mixers in a Continuous Process

In a continuous production process, material flows are fed, processed and discharged simultaneously for freely selectable periods. The final product is produced continuously in a single pass. The process offers maximum efficiency with minimal energy input.

The Benefits of the IKA® Inline Process Technology for Product Manufacture in Batches

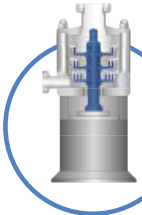

DISPAX-REACTOR DR
 Inline dispersing machine
 23 m/s, 3-stage

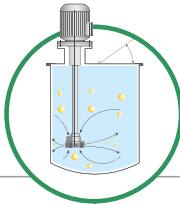

ULTRA-TURRAX UTC
 Batch dispersing machine
 20 m/s, single-stage

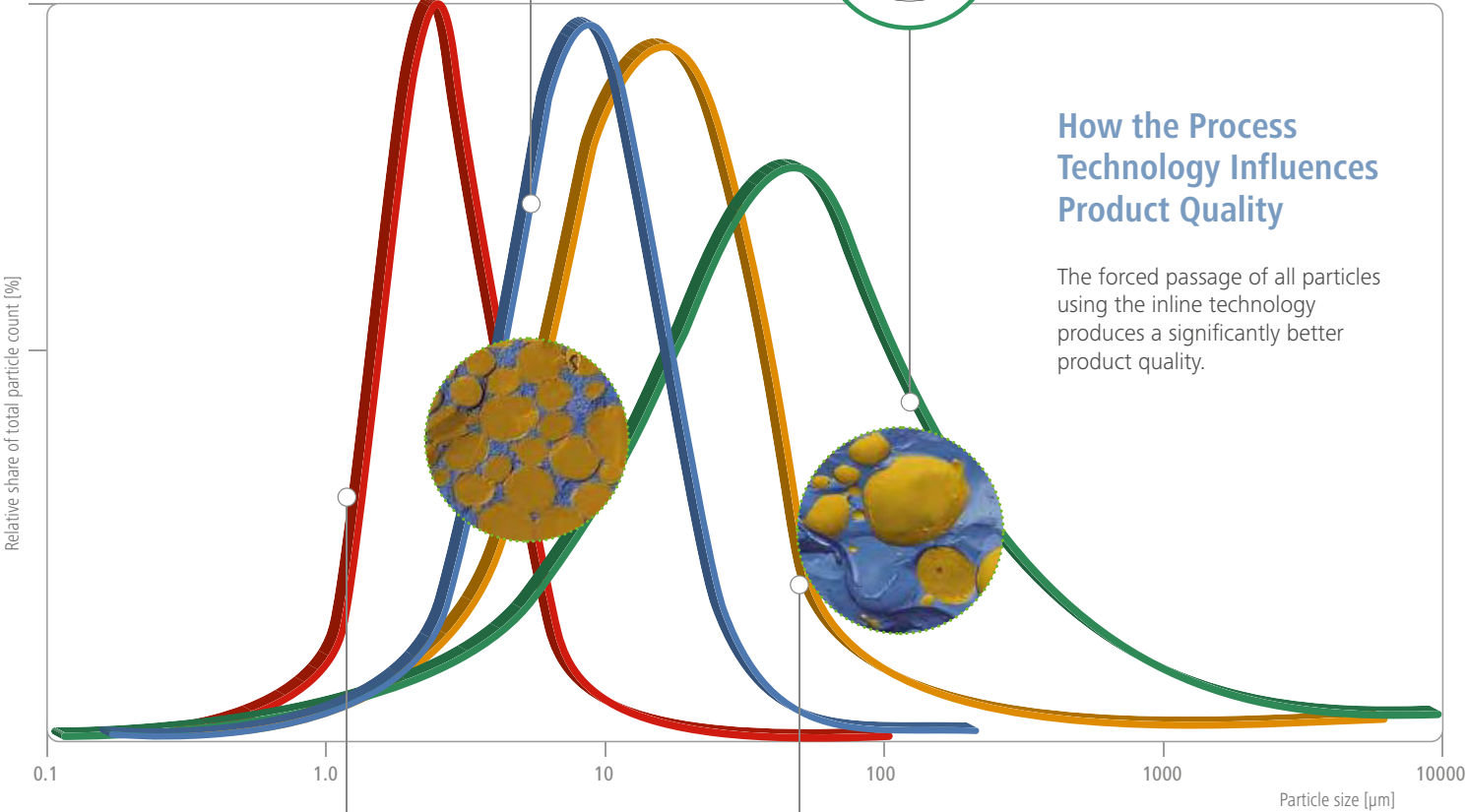

How the Process Technology Influences Product Quality

The forced passage of all particles using the inline technology produces a significantly better product quality.

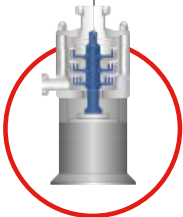

DISPAX-REACTOR DRS
 Inline dispersing machine
 40 m/s, 3-stage

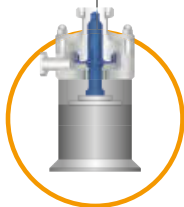

ULTRA-TURRAX UTL
 Inline dispersing machine
 23 m/s, 1-stage

Conventional Batch Process

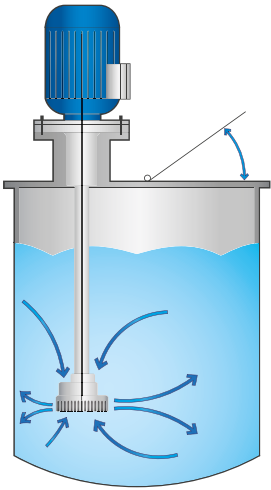

A dispersion unit is installed directly into the container from the top, bottom or side.

The container is filled with a basic liquid. After the dispersing machine is started up, further ingredients are usually added. The dispersing tool recirculates the entire contents of the container and the ingredients are distributed in the receiving liquid. Empirically determined periods ensure that the particles have been processed at least once by the tool. At the end of the dispersing process, the product is discharged.

IKA®+

The reliability of a batch process implemented using state-of-the-art equipment. Highly efficient production, optimized energy demand and product quality.



Batch Inline Process

This batch process is a discontinuous production process. An inline dispersing unit is connected to the storage tank in a recirculation process. While the basic liquid circulates, liquid or powdered substances are added in a highly turbulent area. Depending on the type of unit and the product characteristics, different dosing equipment such as funnels, metering pumps or solids conveyors are used. All ingredients are usually dispersed one at a time. If required, the tank contents are then homogenized with subsequent passes.



Using inline dispersing technology has some significant advantages over conventional batch process:

- > Shorter processing times as a result of more effective mixing
- > Lower total energy use to achieve the desired product quality
- > Narrower particle spectrum; each particle must pass through the dispersion tool at least once
- > Simple reproducibility by determining the passes
- > Lower product heating
- > The inline machine can be used for transfer purposes; as a result, no additional pump is required
- > Reduced risk of potentially explosive substances during production through small production volumes in the high-energy range
- > No risk of vortex formation or air bubbles
- > Well suited for automated processes
- > Product quality independent of operator skills

CMX | Solid-Liquid Mixing in Batch Operation

CMX 2000

The IKA® CMX 2000 is an inline mixer for rapid and homogeneous incorporation of powders into liquids. The circulation of fluid creates a powerful vacuum in the machine that draws in the solids. This ensures an agglomerate free integration of problematic powders that are not easily incorporated into the liquid phase. The multi-level design also enables a stable level of functionality, even when working with high viscosities. The CMX is normally used in a re-circulating inline process. An appropriate quantity of solids is

incorporated into a fixed volume of liquid using the inline device.

The CMX offers a simple, functional and cost-effective method of incorporating solids into liquids, without the need for additional dosing systems. The disadvantages of conventional batch processes using an agitator or jet flow agitator are avoided. No deposits or residues are left on the container walls or agitator shafts. A highly efficient inline process disperses small volumes of powder into a highly turbulent area with no agglomerates.

IKA®+

Reliable Scale-Up

The IKA® CMX 2000 mixer is available in seven different sizes. All sizes of the mixer work with identical process parameters, ensuring a reliable scale-up.

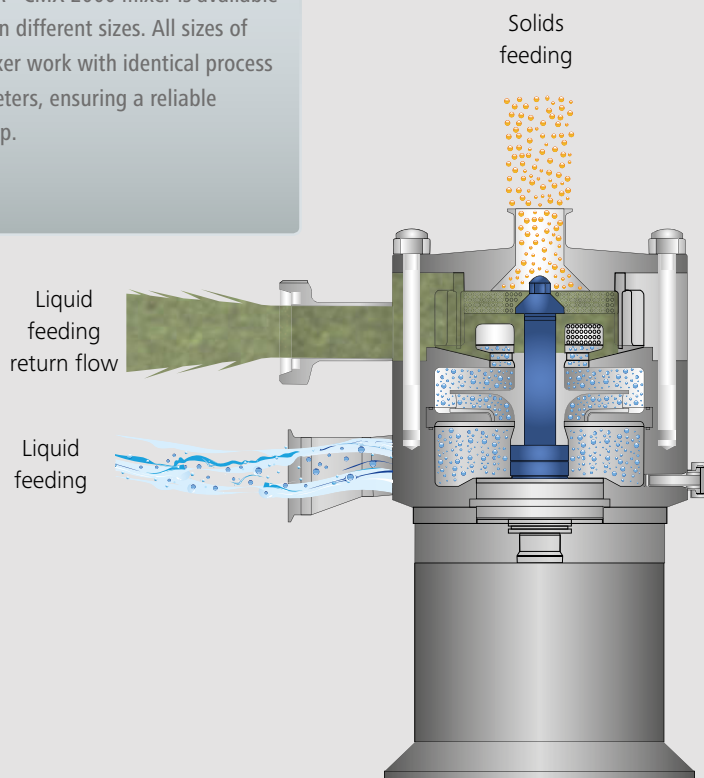

Operating principle of the IKA® CMX

The machine draws the liquid with a low inflow head into the lower area, where it is accelerated through the first stage of the rotor. In the second stage, the solid is dispersed. The liquid displacement and acceleration generates negative pressure. The physical effect is used to draw in the solids from above. Liquids and solids are conveyed separately and do not come together until they reach a highly turbulent area. As the solids enter this area at a high velocity, the formation of agglomerates is avoided. The circulation rate of the liquid and the suction rate of the solids are directly dependent on each other. Streamlined installations on the liquid side minimize the process times.

CMX | Technical Data

Benefits

- Considerable reduction of manufacturing times
- Prevention of dust and solvent emissions due to enclosed system
- Reliable prevention of agglomerates
- Reduced raw material addition time through improved break down of raw materials
- Prevention of deposits in the container
- Self-regulating input of solids and liquids



Explosion proof



Example CMX 2000/10



Speed adjustment



Cleaning in Place



Sterilization in Place



Food Grade



Pharma Execution

Technical Data	CMX 2000/03	CMX 2000/04	CMX 2000/05	CMX 2000/10	CMX 2000/20	CMX 2000/30	CMX 2000/50
Motor output [kW]	0.9	4	15	30	55	110	200
Circulation rate [l/h]*	1,500	5,000	14,000	32,000	70,000	110,000	200,000
Max. solids concentration [mass %]	0 – 50**	0 – 50**	0 – 50**	0 – 50**	0 – 50**	0 – 50**	0 – 50**
Max. diffusion of solids [kg/h]	250	1,300	4,700	8,900	16,200	25,500	46,000
Max. pumping height [m]	20/1***	40/2***	50/5***	50/5***	50/5***	50/5***	50/5***

* Based on water

** Depending on the product attribute

*** In connection with suction

CMX | Solid-Liquid Mixing in Batch Operation

IKA®+

Customization

Depending on customer requirements, the following options are available:

- > Manual or automatic control
- > Fully automatic start-up and shut-down sequence
- > Measurement and control of the ingredients
- > Recipe management
- > Mixing container with agitator
- > Draining and storage equipment for solids
- > Additive dosing

IKA®+

Modular & flexible

Depending on requirements, the solid material can be fed via a bulk bag unloader, a funnel, or directly from the bag via a suction wand.



The picture shows a typical arrangement of a CMX with a container. The liquid flows from the bottom of the container with low static level into the machine. The machine's product outlet is also connected to the container via a recirculation pipe. During the process, the machine circulates the contents of the container in a similar manner to a centrifugal pump. During circulation, the solids are incorporated into the liquid via the mixing chamber of the CMX. Once all of the solids have been incorporated, circulation usually continues and the mixture is homogenized. There are several methods and draining systems for solid processing. This procedure with funnel is suitable for automation.

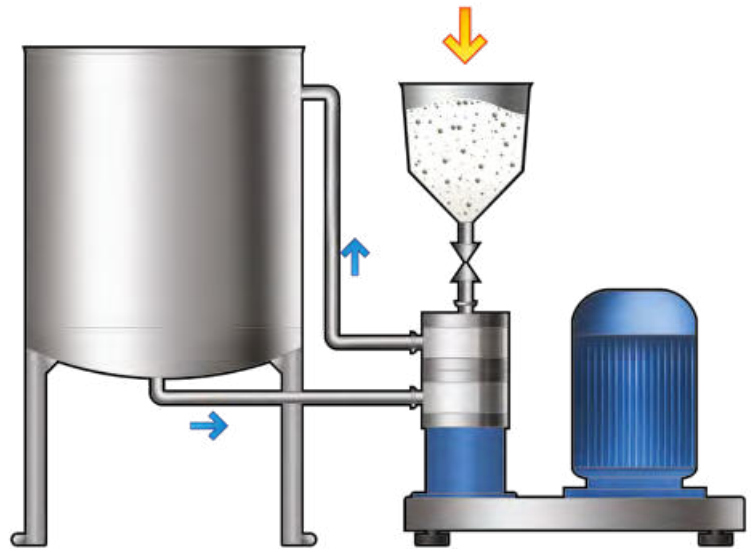

Suction using a suction wand directly from a bag reduces handling and minimizes dust exposure. This method is particularly suitable for very light and dusty bulk solids such as fumed silica (e.g. Aerosil®, HDK®) or activated carbon.

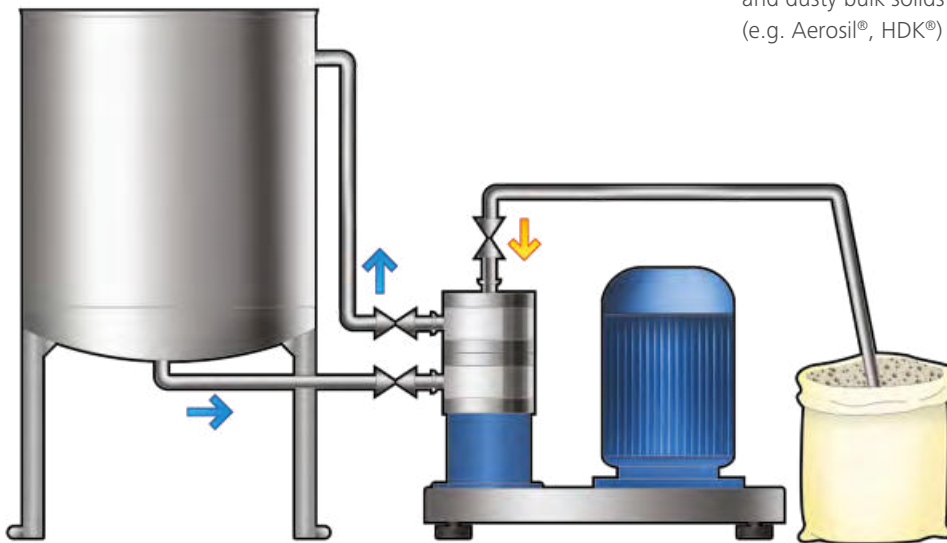

Application Information

Industry: Chemical industry
Application: Mixing water with sodium sulfate
Final product: Concrete additive

Process type: Batch inline recirculation

Mixing — homogenizing

Previous Processing Procedure

In the past, solids were taken from bags and manually put into a mixing container with a stirrer through an opening in the container cover, where it was mixed with water. This led to high dust emissions and the formation of lumps in the product. The product quality depended very much on the skill of the operator.

IKA® Solution

A complete system was designed, consisting of a mixing container with a jet flow agitator, which is connected to the CMX solid-liquid mixer via an inlet pipe and a recirculation pipe. During processing, the product is circulated through the mixing container and CMX. The solids are fed from a bulk bag into a funnel above the inline machine is also integrated into the system.

The desired batch size and the recipe can be selected using the electronic control system. Depending on the specified volume of liquid, the required quantity of solids is automatically determined and controlled by load cells on the bulk bag frame. The process starts when the CMX machine is started up and the valves between the container and the inline machine are automatically and simultaneously opened.

When the flow meter detects sufficient liquid movement, the valve of the solids container opens and the solids are drawn into the CMX where they are dispersed. When the solids material goes below the minimum fill level, the weighing system will, via an optical signal, indicate that the bulk bag must be replaced. The solids valve closes automatically and the product continues to circulate through the mixing container and CMX. After the control system confirms that the bulk bag has been replaced, the valve re-opens to feed in the solids again. Once all the solids have been fed, the product continues to circulate for an adjustable period of time; after which, the machine stops and the valves close. At the end of the process, the product is delivered to a storage tank via the CMX system.

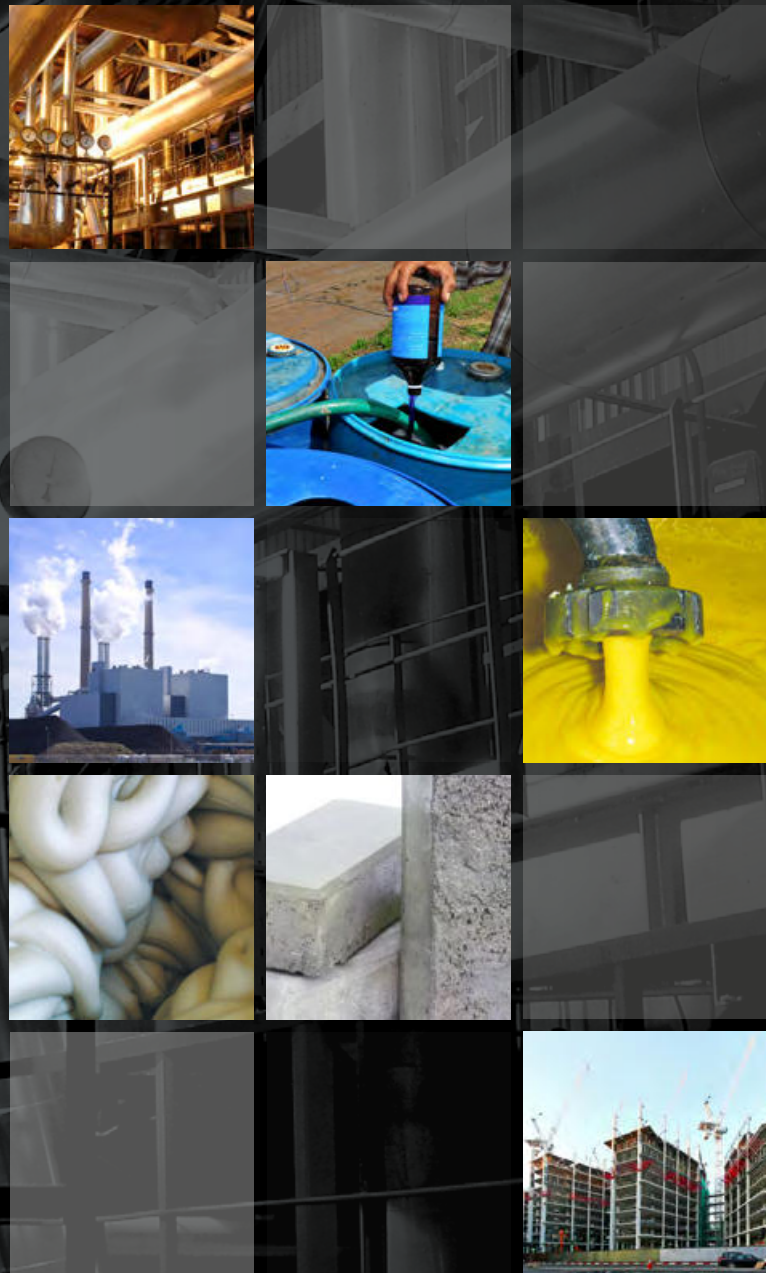



Included

- > CMX 2000/20
- > Bulk bag device
- > Solids fluidizer
- > RTS 280 jet flow agitator
- > 5,000-l mixing container

Customer Benefit

- > Lump-free solids feeding
- > No deposits on stirrer or container wall
- > Product quality independent of operator skills
- > Minimized dust and odor emissions
- > Automated process



The Benefits of IKA® Inline Process Technology for Continuous Process Product Manufacture

IKA® Continuous Inline Process

In this process, liquids/liquids, solids/liquids or liquids/gases are fed in proportion to their quantity into an inline dispersing machine in a single pass. They are continuously mixed, dispersed and discharged. Blending small volumes in a highly turbulent area is an extremely efficient method.

The system operates continuously or intermittently; for example, to fill a container or to produce a limited quantity of the product. Each ingredient is fed via a separate metering device. The specific energy input and the time spent in the highly turbulent area determine the end product.

Energy Consumption over the Duration of the Process

Comparison of batch and continuous processes using the example of producing 400 l of product with a planetary mixer and an inline mixing machine

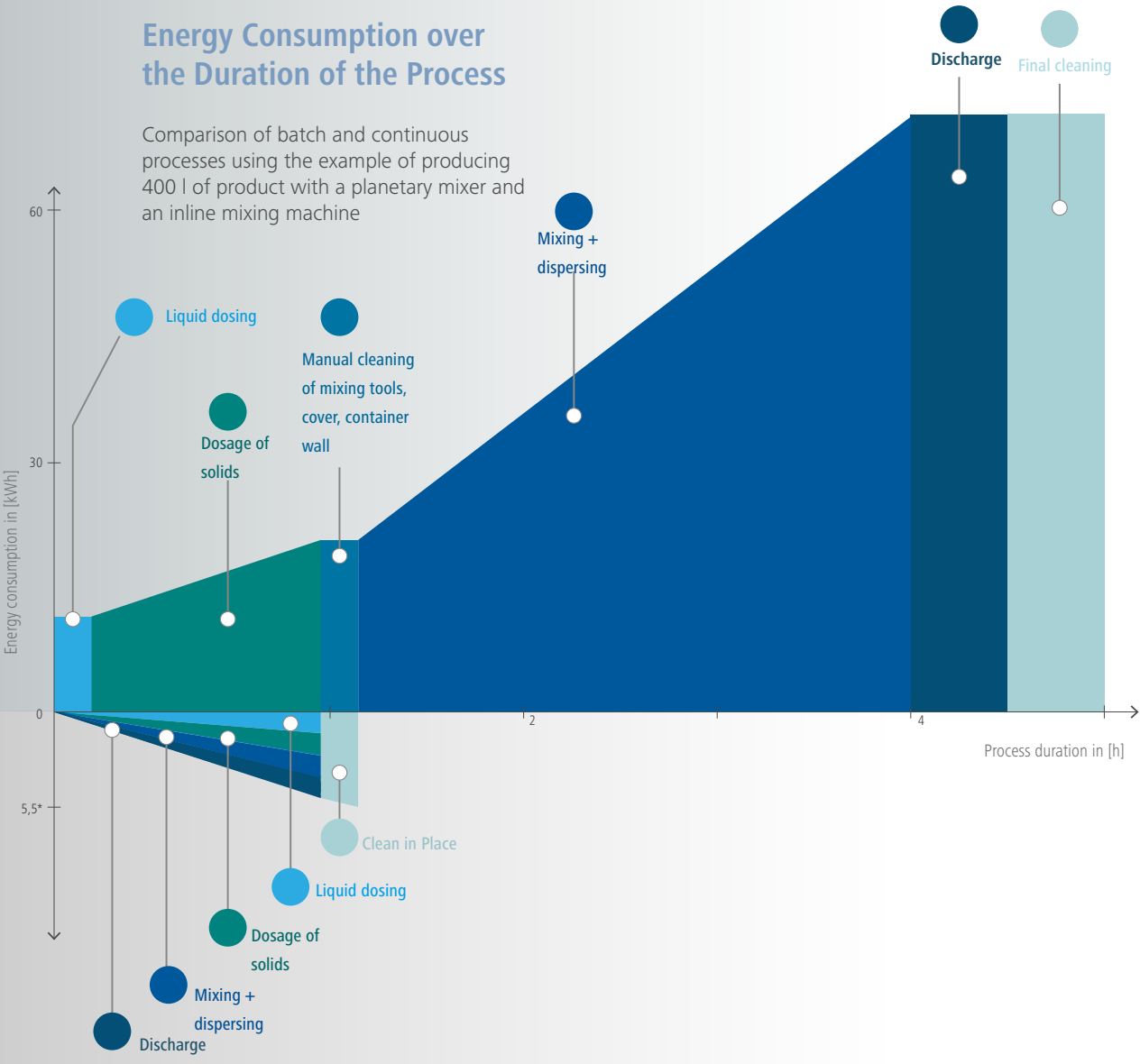

Batch method sequential process steps

- Batch mixer
- > Drive power 15 kW
- > Volume 400 l
- > Batch process



Continuous method parallel process steps

- Continuous mixing
- > Drive power 5.5 kW
- > Throughput 400 l/h
- > Inline process





The use of continuous processes with inline dispersing technology offers the following benefits:

- > High throughputs with minimum space requirements, no batching tanks
- > Manufacture of a finished product in a single pass
- > Throughput and dispersion capacity are separated and are independently adjustable
- > Minimal product heating as a result of a single-pass process
- > 100 % reproducibility of the production result
- > Lower total investment cost for the same output
- > Can be fully automated
- > Product manufacture in continuous operation or required quantities for just in time manufacturing processes.
- > Cleaning during the run, minimizes waste
- > Ideal for dispersing additives in viscous media



MHD
Continuous dispersing
unit for liquids + solids

IKA®+

Maximum efficiency with minimum space requirements for products manufactured by continuous operation without cleaning and set up times.

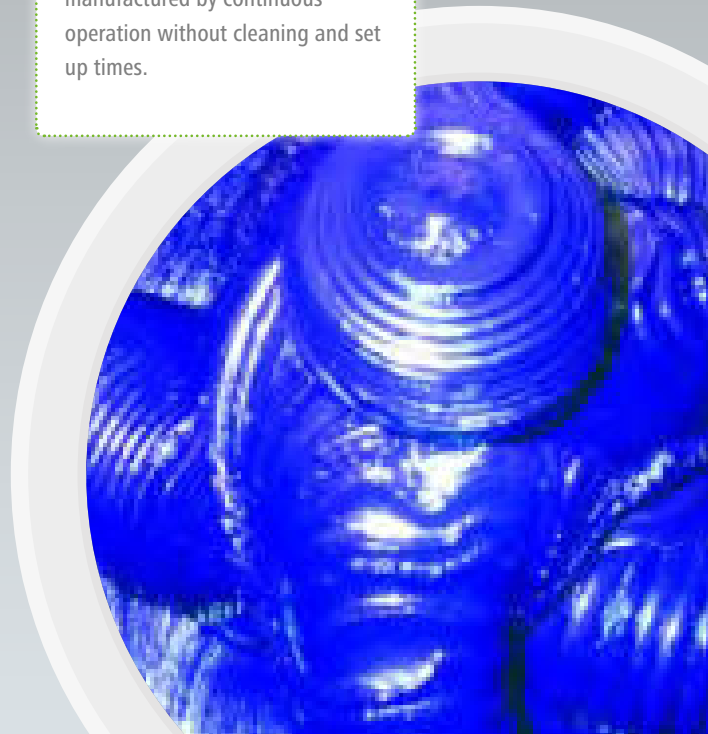

MHD | Continuous Solid-Liquid Mixing

The IKA® MHD offers top-quality, fully automatic continuous mixing; in a single pass.

The MHD mixing system allows liquids to be mixed and dispersed with solids (powders or granules) in a continuous process with no dust emissions.

The core element of the continuous solid-liquid mixing system is the MHD machine (mixing — homogenization — dispersing). The MHD accurately combines the solid and liquid and disperses them into a homogenous final product in a single pass.

The throughput is determined by the dosing devices that feed in the ingredients. The dispersion quality depends on the speed and tools.

Wetting in the highly turbulent area is a reliable method of preventing agglomerates. The additional dispersing step ensures a finished product is produced in a single pass. This means any proportions of the solid/liquid phases can be set, depending on the product characteristics. The single pass mode of operation minimizes heating of the product.

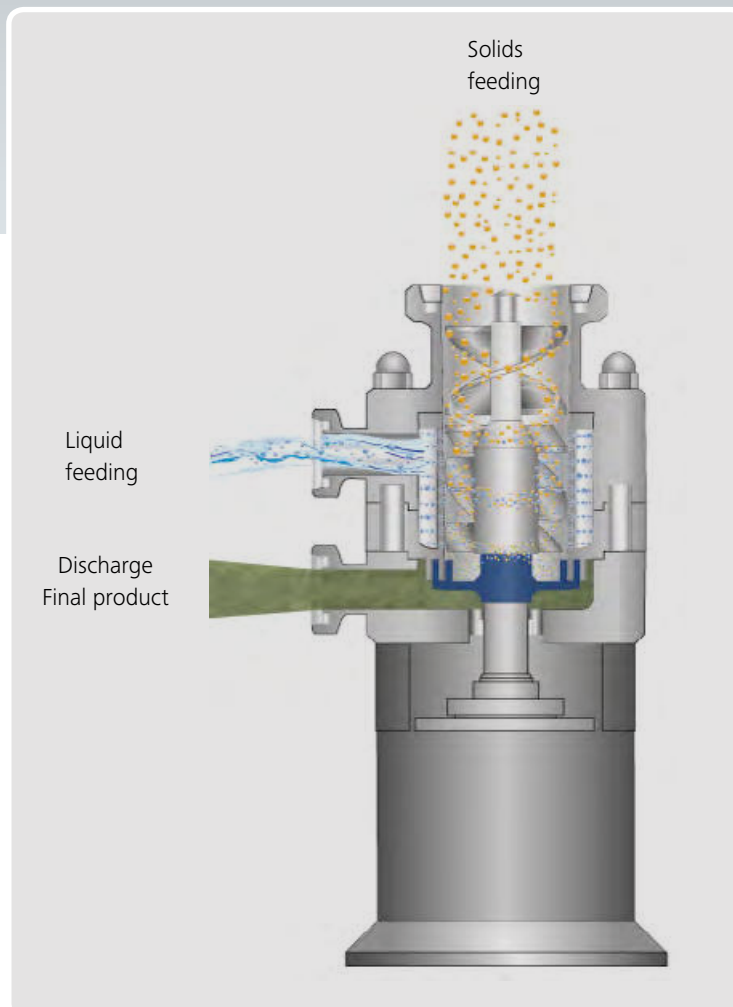

The solids feed auger prevents caking of the dosed powder and ensures that moisture does not reach the dry area. The liquid is injected via an injector and the solid and liquid phases meet in the mixing chamber. The mixing vanes use high turbulence to ensure agglomerate-free mixing. The subsequent rotor-stator dispersing tool guarantees complete inclusion and a homogeneous final product with the finest particle sizes. The MHD has its own conveying capacity and can pump the final product to the next process step or, for example, into a storage tank. For extreme viscosities or very high pressure losses after the MHD, discharge pumps are situated directly downstream to improve the reliability of the process.

MHD | Technical Data

IKA®+

When It Gets Thicker

The patented machine allows solid concentrations up to 80 % to be processed in a single pass with minimal product heating.



Ex-protected



Speed adjustment



Cleaning in Place



Sterilization in Place



Food Grade



Pharma Execution

	MHD 2000/03	MHD 2000/04	MHD 2000/05	MHD 2000/10	MHD 2000/20	MHD 2000/30	MHD 2000/50
Technical Data							
Motor output [kW]	0.9	2.2	5.5	11	18.5	30	75
Circumferential speed [m/s]	23	23	23	23	23	23	23
Total throughput [l/h]	5 – 40	50 – 200	150 – 750	500 – 2,500	1,500 – 7,500	4,000 – 20,000	8,000 – 40,000
Max. solids concentration (mass %)	0 – 80*	0 – 80*	0 – 80*	0 – 80*	0 – 80*	0 – 80*	0 – 80*
Max. solids throughput [l/h]**	40	100	500	1,300	2,800	8,500	18,000
Max. pumping height [m]	2	1 – 5	5 – 20	5 – 20	5 – 20	5 – 20	5 – 20
Max. solids particle size [mm]	2	5	10	15	20	30	50
Max. viscosity of the final product [mPas]	10,000	50,000	100,000, with additional discharge pumps up to 200,000				

* Depending on the product characteristics, mainly final viscosity

** For a bulk density of ~0.7 kg/l

MHD | Proportional Powder Wetting

Continuous production means a continuous supply of raw materials. Liquids are usually extracted from a piping system or a storage tank and fed in doses into the MHD using a variable-speed displacement pump or, if there is a sufficient pressure head, a metered flow control valve. Solids are fed using a dosing device such as an auger filler, rotary feeder or vibration conveyor.

The dosing accuracy is crucial for the consistent quality of the final product. Based on many years of experience, IKA® currently builds fully automated complete systems for continuous processes. These are successfully used in a diverse range of fields – some also in a 24/7 operation – (e. g. in fertilizer manufacturing or in the paper industry).

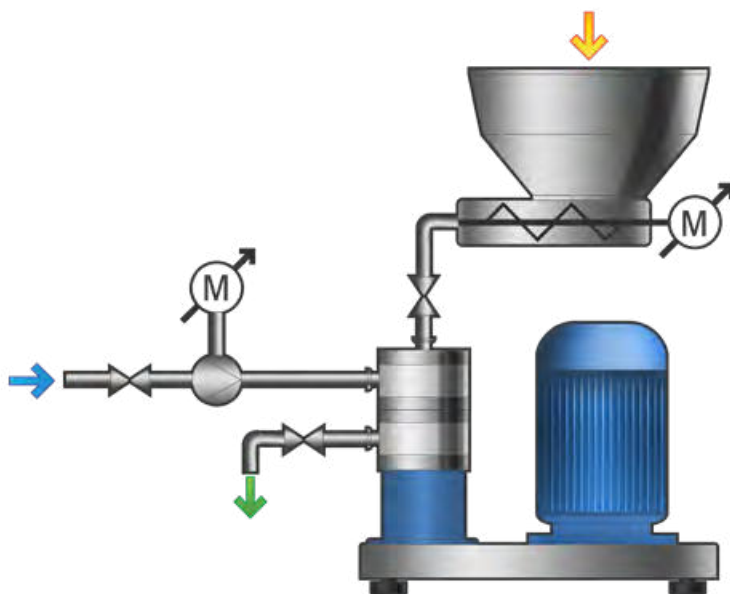
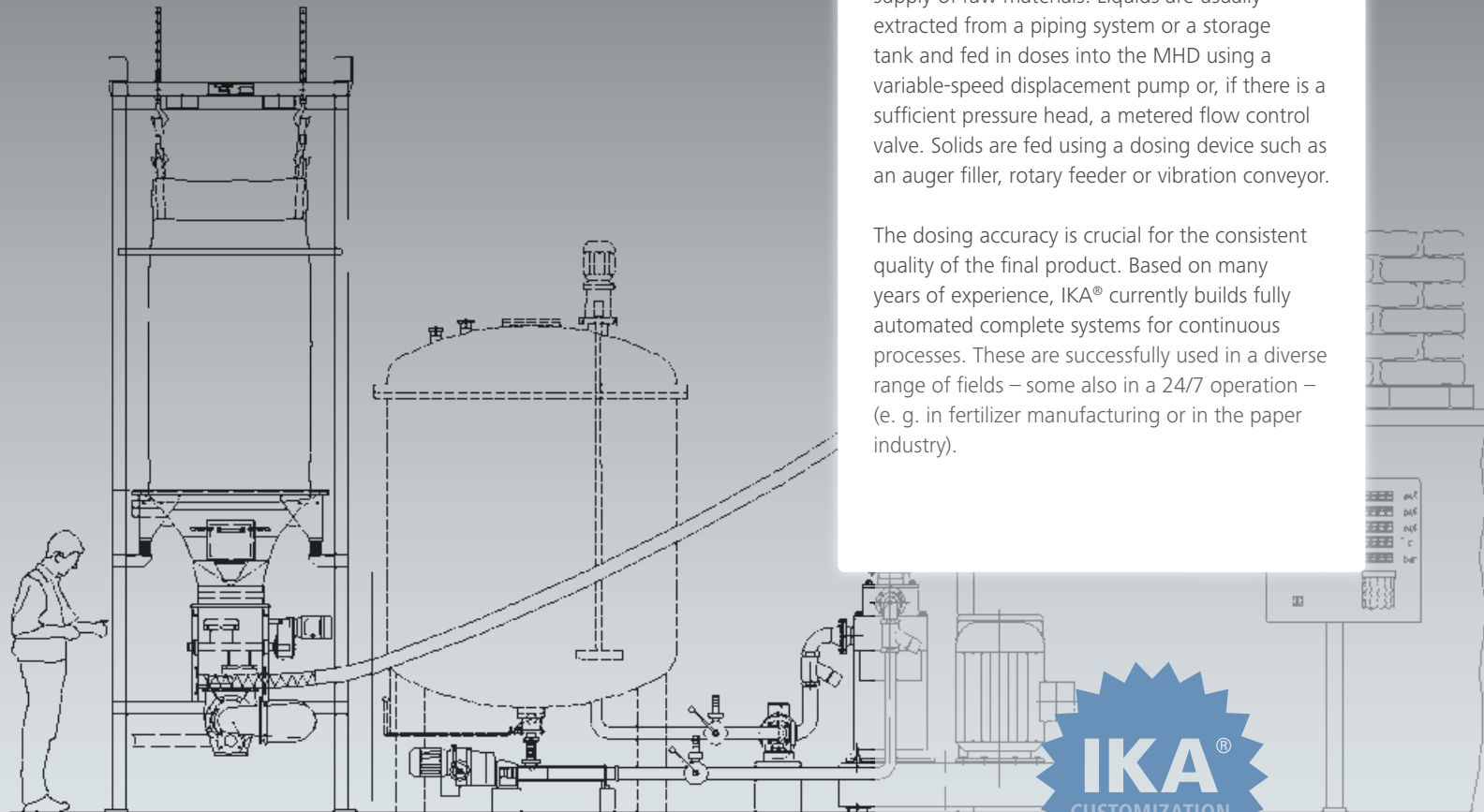

With a volumetric mode of operation, the dosing devices run at a constant speed. The associated dosing quantities must be calibrated beforehand or set according to a volumetric curve. This mode of operation is suitable, for example, for pilot plants, less stringent requirements for accuracy, and for semi-continuous modes of operation, such as filling storage tanks.



The solids dosing devices are usually refilled from bulk bag systems or silos using appropriate conveying equipment.

IKA®+

Customization

Depending on customer requirements, the following options are available:

- > Manual or automatic control
- > Control of individual throughputs
- > Recipe management
- > Storage tank for ingredients
- > Heated piping
- > Additive dosing
- > Buffer tank
- > Inerting

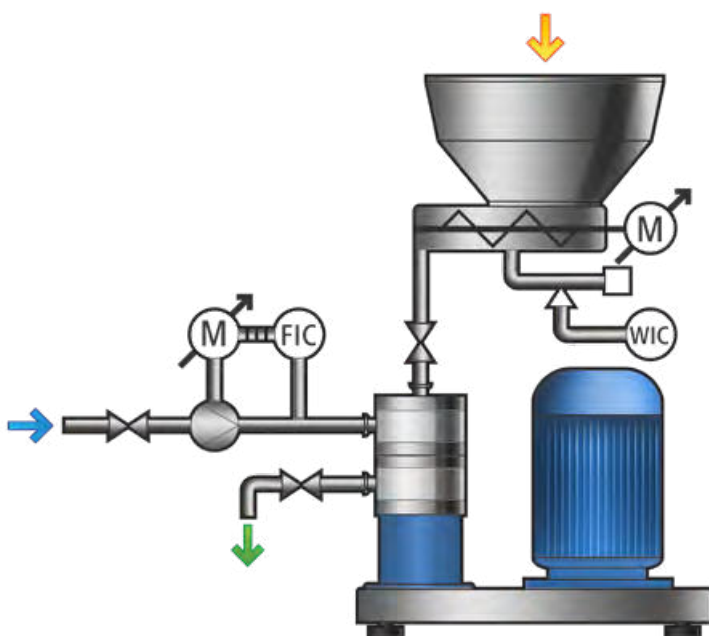

In a quantity-controlled mode of operation, the throughputs of the liquid components and solids are continuously measured, and the drive systems are readjusted to match the target throughput. Flow meters, which determine the actual throughput are usually used for the liquids. Depending on the deviation, adjustments are made by controlling the speed of the feed pump or adjusting the flow control valve. Gravimetric systems are normally used for the solids.

The mass flow per unit of time is registered using weighing systems, and the speed of the dosing device is also adjusted here, depending on the deviation. The quantity-controlled mode of operation enables very high degrees of accuracy and is ideal for fully continuous processes.

Application Information

Industry: Paper industry

Application: Mixing and dispersing of water with polymer solution and modified starch

Final product: Starch suspension

Process type: Continuous, inline, single pass, mixing — dispersion

Starting Point

The paper industry is one of the industrial sectors where fully continuous processes have been state of the art for decades already. Producing recycled paper is a specific application where modified starch (e. g. potato starch, corn starch) is added to the material in order to achieve certain strength properties. The molecular chains of the starch interlink with the paper fibers, which become ever shorter as they go through numerous recycling cycles and are no longer sufficiently binding. Adding binding agents achieves consistently good strength properties, which is a decisive factor in the manufacture of cardboard packaging paper. An example of this type of binder is, for example, a cereal flour-based starch product that is soluble in cold water.

IKA® Solution

For the manufacture of this product, the manufacturer identified the MHD as the only effective mixing and dispersion unit to enable the production of a high quality suspension for processing in a single pass in a paper machine. An additional requirement was a mobile system for tests in different paper mills at production scale.

In the case described, the liquid component (water) is fed in a dosed manner using speed-controlled displacement pumps with a stable characteristic curve. In addition, a proportional quantity of a second liquid component in the form of an additive is fed in. The throughput is detected in each case by a flow measurement.

The solids are conveyed by a differential weigh feeder, designed as an auger filler in a cradle frame. The actual mass flow is determined through the reduction in weight per unit of time, and the drive system is readjusted according to the desired target value. If the dosing tank runs dry, it is automatically refilled from the big bag in a short period of time. During this time, the dosing continues in a volumetric manner.

With the plant, up to 20 m³/h of starch suspension with solids concentrations up to 15 % can be produced in 24-hour continuous operation.





Included

- > MHD 2000/30
- > Bulk bag unloader
- > Gravimetric solids dosing
- > Liquid dosing
- > Buffer tank
- > Container system

Input Materials

- > Water
- > Polymer
- > Modified starches

Customer Benefit

- > Lump-free incorporation and dispersion of solids
- > Mobile production-scale test unit
- > Fully automatic operation
- > Suitable for a 24/7 operation



DPV | Continuous Mixing System for Liquids

The IKA® DPV mixing systems are used for applications where two or more liquids are to be mixed proportionally and homogeneously in a single pass.

One of the main applications of the standardized IKA® DPV dilution plants is the dilution of 70 % lauryl ether sulfate (LES) to a concentration of approximately 28 % in the manufacture of detergents. Dilution is virtually impossible in a batch process due to a dramatic increase in viscosity, and is therefore carried out in an inline process. The delivery of concentrated LES and dilution on site saves significantly on transportation costs, and thus, the cost of the DPV plant will be recouped in a short period of time. There is also high degree of flexibility in terms of the adjustable concentration and possible recipes and quantities of multi-component mixtures produced. The DPV plant has demonstrated its worth — both

in the manufacture of household detergents and in the production of body washes and hygiene products.

Other typical applications for DPV plants include mixing liquids with different viscosities and the dispersion of very small quantities in a main mass flow, such as the introduction of fragrances. Another classic application of the DPV is for processes where the mixing of two or more liquids causes a reaction; such as mixing of vegetable oil with alcohol and a catalyst for the production of biodiesel.

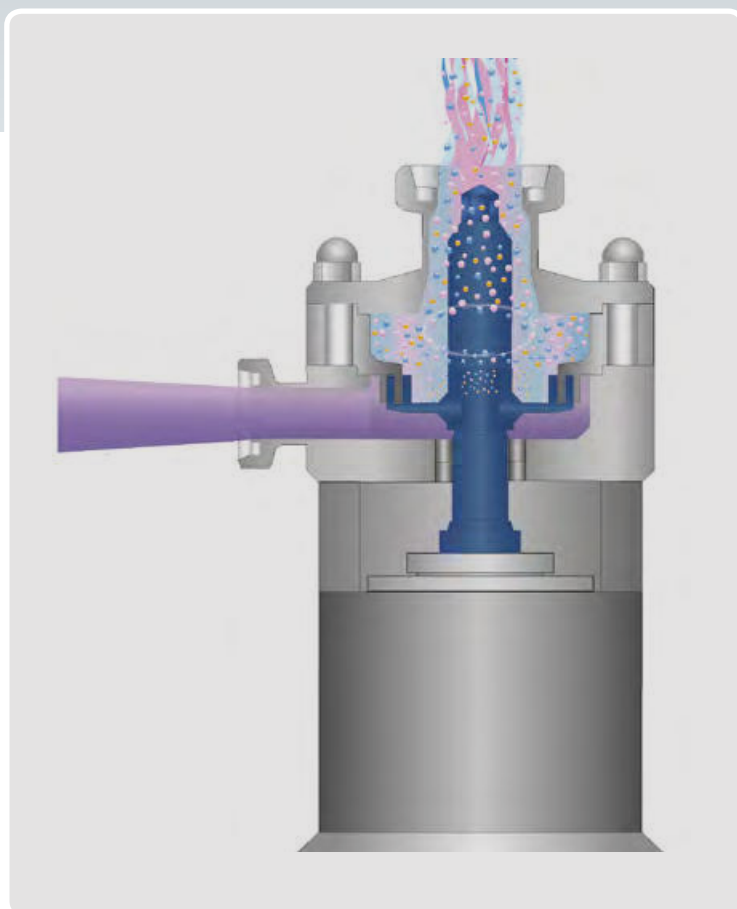

DPV | Continuous Mixing with Rotor-Stator System

The DPV mixing system allows liquids to be mixed and dispersed in a single pass in an enclosed continuous process.

The core element of the DPV plant is the inline dispersion unit, which is fitted with different processing parts depending on the application.

The IKA® UTL, DR, or MK inline dispersion systems, used in the DPV plants, efficiently mix and disperse through the forced passage of the entire quantity of the product.

The throughput is determined by the dosing devices that feed in the ingredients. The quality of the dispersion is very much dependent on speed, tools, and the time spent in the system.

DPV | Technical Data

IKA®+

Process Efficiency

Continuous operation ensures an efficient and economical operation with minimum space requirements.



Speed adjustment



Cleaning in Place



Sterilization in Place



Food Grade



Pharma Execution



Ex-protected



	DPV 3000	DPV 7500	DPV 15000
Technical Data*			
Power input [kW]	8	16	30
Total throughput [l/h]	3,000	7,500	15,000
Concentrate feed rate [l/h]	500 – 1,200	1,000 – 2,500	2,500 – 6,000
Feed rate for dilution fluid [l/h]	500 – 2,500	2,000 – 5,000	4,000 – 10,000
Circumferential speed [m/s]	23	23	23
Max. end viscosity [mPas]	200,000	200,000	200,000
Max. solids particle size [mm]	2	5	10
Max. viscosity of the final product [mPas]	10,000	50,000	

* In the LES application example

DPV | Dilution with IKA® Quality

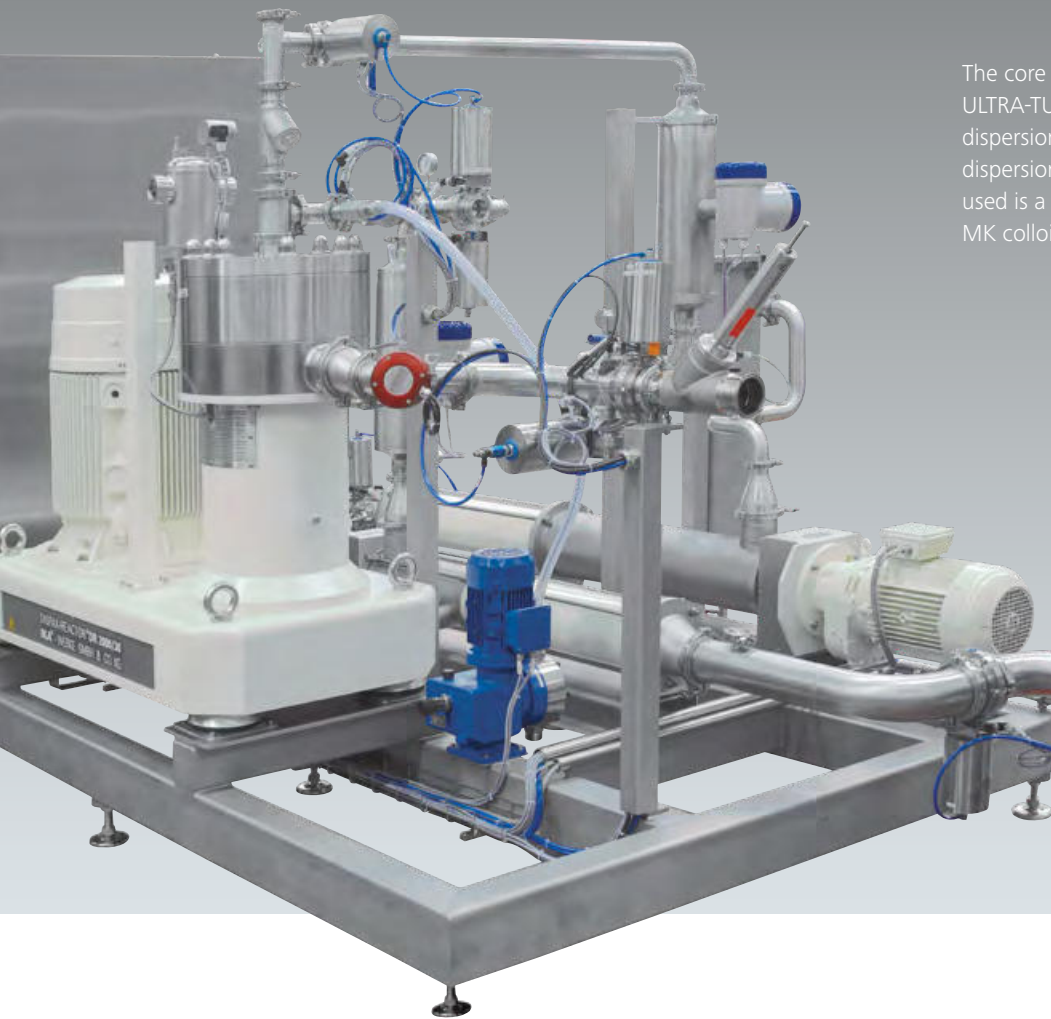

The core element of a DPV plant is an ULTRA-TURRAX® standard single-stage inline dispersion unit. For applications with higher dispersion quality requirements, the homogenizer used is a three-stage DISPAX-REACTOR® or an MK colloid mill.

IKA®+

Reproducibility

Fully reproducible as a result of a single pass

In-time production

No minimum quantity required.
Production of the precise quantity required — in the time available.

Easy cleaning

CIP cleaning during throughput.

Additional components of the DPV plants are the pumps for the proportional feeding of ingredients with the connecting pipes. The plant is complemented by a base frame and, depending on the version, by the associated instrumentation and controls, as well as raw materials containers. The components are mounted on the frame using a compact layout, with full piping and wiring, and are pre-tested. This minimizes installation time on site, which only involves connecting the feed lines for the raw materials and auxiliary substances.

The ingredients are fed into the dispersion unit with a high degree of accuracy from a raw materials

collector via metering pumps with a stable characteristic curve. Depending on the configuration level, the flows are set manually or controlled automatically. The individual material flows do not come into contact with each other until they reach the dispersion tool. The mixing energy is created here through turbulence and shear. The amount of energy input is determined by the operational parameters of the dispersion unit, such as tool configuration and circumferential speed. With lower viscosities, the UTL or DR conventional rotor-stator system is usually used. With higher viscosities, improved efficiency is achieved with the MK tool and its large shear plane.

The essential characteristic of the dilution plant is the optimum design of the dispersion process: the phases to be mixed do not meet until they reach the highly turbulent area immediately before or in the dispersing tool, which prevents unwanted reactions such as clumping.

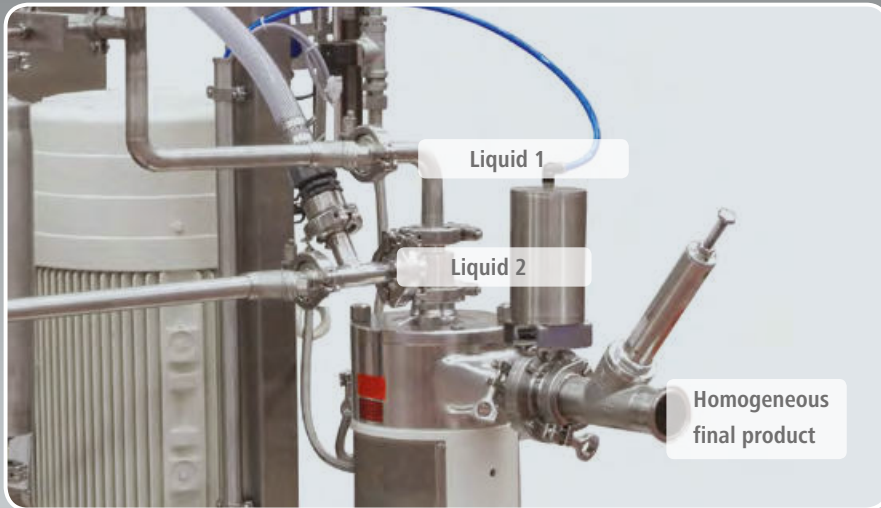

IKA®+

CUSTOMIZATION

Depending on customer requirements, the following options are available:

- > Manual or automatic control
- > Measurement and control of individual throughputs
- > Recipe management
- > Storage tank for ingredients
- > Heated piping
- > Additive dosing



UTL module

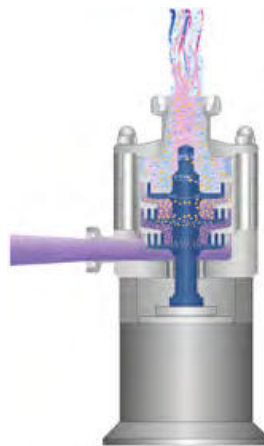

DR module



MK module

Application Information

Industry: Chemical industry

Application: Mixing oil and water

Final product: Oil-in-water emulsion

Process type: Continuous, inline, single pass, mixing — emulsifying — diluting

Previous Processing Procedure

Batch production with manual liquid feeding.

A uniform particle spectrum is a prerequisite for a stable emulsion. Batch production and the sometimes very high viscosity only allowed reproducible production to a limited extent.

IKA® Solution

The DPV plant is used for the continuous mixing, emulsification and dilution of different oil emulsions in a single pass. Product components are silicone oil or mineral oil, water and an emulsifier. The input of a high specific energy is required for flawless emulsification with a narrow droplet spectrum to achieve good long-term stability. This is achieved by first producing a very viscous intermediate product, which is then diluted inline. The plant is installed on a base frame and connected to the raw materials feed through pipelines. The dispersed product is delivered into storage tanks.

With the help of the plant control system, different product recipes can be stored with their individual product components. Other parameters, such as total throughput flow or planned production volume, can be pre-selected. After the recipe is specified, the fully automatic process can begin. Several metering pumps add the various additives in accordance with the recipe. Measurement of the actual flow rate and the automated adjustment of the feed rate ensure high-precision dosing with deviations of less than 0.5%. This guarantees a good, stable product quality. The pumps convey the additives into the MK high-performance disperser. The special design of the raw material feed and the dispersing tool with a circumferential speed of up to 50 m/s produce microscopic droplets. After the process, the highly concentrated emulsion is diluted with water inline in the UTL 2000 homogenizer and discharged.

Various sensors ensure a smooth system operation. Shortages of raw materials, such as insufficient liquid in the reservoir, interrupt the process. Other blocks stop the production; for example, when the collecting container is too full to take the required production volume. Automatic valves switch according to the process step and the recipe. Various manual valves can be used for sampling. The whole system can be cleaned using the CIP process. For cleaning, clear water or detergent is fed into the dispersion unit and piping. The whole system can be emptied at the lowest point via a drainage valve.





Included

- > MK 2000/10
- > UTL 2000/05
- > Metering pumps
- > Piping
- > Instrumentation
- > Frame
- > Controls

Input Materials

- > Water
- > Silicone oils
- > Emulsifiers

Customer Benefit

- > Automation with high degree of flexibility for the recipe
- > Flexible production quantity, depending on current requirements
- > Product quality independent of operator skills
- > Minimized material loss and cleaning requirement
- > Small space requirement

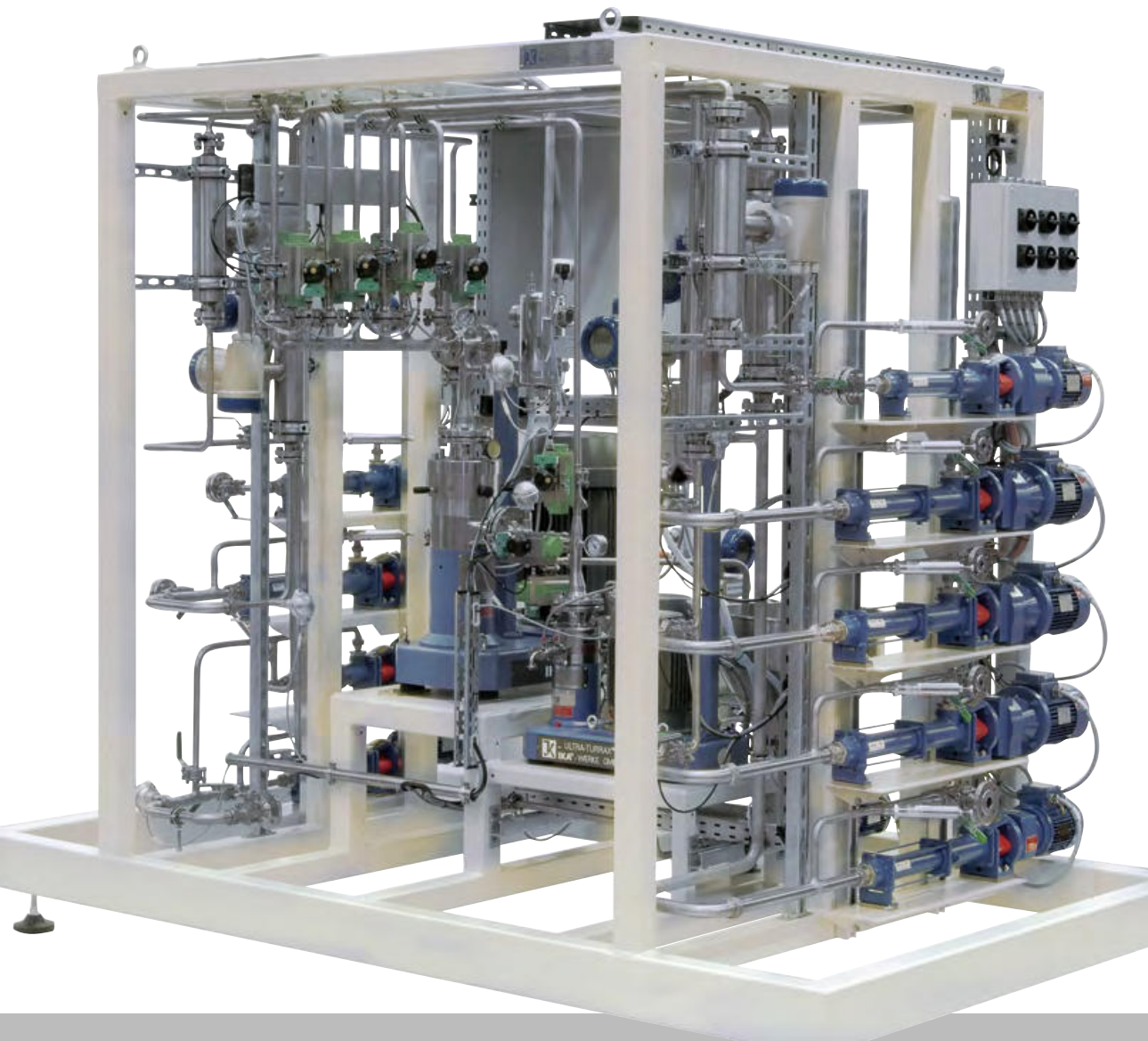

Pilot plants | Develop — Optimize — Scale

From Laboratory to Production

IKA® pilots link your laboratory with production. With the same machines and equipment series for low and high throughput rates, IKA® ensures a seamless transition from product development to mass production.



Speed adjustment



Cleaning in Place



Sterilization in Place



Food Grade



Pharma Execution



Ex-protected

magic PLANT inline with DBI module.

The magic PLANT is specially designed for small-scale simulation of process and product requirements. As soon as a satisfactory product can be produced at the pilot scale, the next step is to transfer the manufacturing process to the production scale. The magic PLANT system and its extensive range of accessories can be adapted to a wide range of applications.

IKA® pilots can help you to:

- > Find the right technology for your application
- > Determine the required energy input
- > Establish the quality and quantity of the required raw materials
- > Define the quality level of the finished product
- > Select the appropriate plant size for the specified throughput volumes or batch sizes
- > Simulate existing production processes on a small scale



LABOR-Pilot set up as an MHD plant

IKA®+

Process Efficiency

Continuous operation ensures a very efficient and economical operation with minimum space requirements.

The magic LAB®, LABOR PILOT and PROCESS PILOT mixers are perfectly suited for the optimization of product recipes and process parameters. They are characterized by identical processing parts and the same specific energy input as the corresponding IKA® inline production machines. They enable the production of fine dispersions, lump-free and dust-free incorporation of powder in liquids, as well as homogeneous mixtures at the laboratory level. An extensive range of accessories is available to develop these inline mixing machines into complete laboratory and pilot mixing systems.

Pilot Plants | One Machine - Many Mixing Tasks



Speed adjustment



Ex-protected



Cleaning in Place



Sterilization in Place



Food Grade



Pharma Execution

IKA® magic LAB®

The unique and versatile laboratory-scale machine used for the development of new products and for product and process optimization. The seven interchangeable mixing modules make it the ideal machine for continuous, recirculation and batch processes. Standard design with the ULTRA-TURRAX® UTL module.

IKA® magic LAB® XP

The magic LAB® XP is an upgraded version of the magic LAB®. It has been developed for applications that are subject to one or more of the following requirements:

- High pressure/high vacuum
- High power requirement
- Processing of abrasive products

Technical Data

Supply voltage [V]	Single-phase 220 – 240
Motor output [kW]	0.9
Max. product temperature in continuous/short time operation [°C]	80/120
Max. vacuum/pressure [bar]	-0.5/2.5
Nominal speed [min ⁻¹]	14,600
Adjustable speed range [min ⁻¹]	3000 – 26,000 *
Circumferential speed ** [m/s]	23
Throughput volume** [l/h]	100
Dimensions of basic unit (W x D x H) [mm]	170 x 270 x 215
Weight of basic units [kg]	7
Dimensions of transport box (W x D x H) [mm]	350 x 460 x 560
Weight of basic unit in transport box [kg]	20

* Incl. controller

** At 14,600 min⁻¹, UTL module, 4 M, water

magic LAB® 2000/03

Supply voltage [V]	Single-phase 220 – 240
Motor output [kW]	0.9
Max. product temperature in continuous/short time operation [°C]	80/120
Max. vacuum/pressure [bar]	-0.5/2.5
Nominal speed [min ⁻¹]	14,600
Adjustable speed range [min ⁻¹]	3000 – 26,000 *
Circumferential speed ** [m/s]	23
Throughput volume** [l/h]	100
Dimensions of basic unit (W x D x H) [mm]	170 x 270 x 215
Weight of basic units [kg]	7
Dimensions of transport box (W x D x H) [mm]	350 x 460 x 560
Weight of basic unit in transport box [kg]	20

magic LAB® XP

Supply voltage [V]	3-phase 380 – 420
Motor output [kW]	1.5 – 4
Max. product temperature in continuous/short time operation [°C]	120
Max. vacuum/pressure [bar]	-1/7
Nominal speed [min ⁻¹]	14,600
Adjustable speed range [min ⁻¹]	see CONTROLLER
Circumferential speed ** [m/s]	14,600
Throughput volume** [l/h]	10 – 100
Dimensions of basic unit (W x D x H) [mm]	450 x 250 x 930
Weight of basic units [kg]	48
Dimensions of transport box (W x D x H) [mm]	–
Weight of basic unit in transport box [kg]	–

magic LAB® XP CONTROLLER

Max. motor output [kW]	3
Frequency range (Hz)	20 – 87
Speed range [min ⁻¹]	3,000 – 23,500
Circumferential speed [m/s]	5 – 37

Technical Data

Max. motor output [kW]	3
Frequency range (Hz)	20 – 87
Speed range [min ⁻¹]	3,000 – 23,500
Circumferential speed [m/s]	5 – 37



IKA® LABOR-PILOT

Inline pilot dispersing machine with options for expansion to a production machine. Standard design with the ULTRA-TURRAX® UTL module.

IKA® PROCESS-PILOT

Inline pilot dispersing machine with mechanical seal. Suitable for use under vacuum/pressurized conditions and at high temperatures. Standard design with the ULTRA-TURRAX® UTL module.

	LABOR-PILOT 2000/04	PROCESS-PILOT 2000/04
Technical Data		
Operating voltage [V]	3-phase 380 – 420	3-phase 380 – 420
Motor output [kW]	1.5	2.2
Max. product temperature [°C]	120	120
Max. process pressure/vacuum [bar]	3/-0.5	10/-1
Speed [min ⁻¹]	8050	8050
Circumferential speed [m/s]	23	23
Throughput [l/h]*	500	500
Dimensions (W x D x H) [mm]	450 x 250 x 350	425 x 250 x 900
Weight of basic units [kg]	36	53

	LABOR-PILOT CONTROLLER	PROCESS-PILOT CONTROLLER
Technical Data		
Max. motor output [kW]	2.2	4
Frequency range (Hz)	20 – 87	20 – 87
Speed range [min ⁻¹]	3170 – 13,789	3170 – 13,789
Circumferential speed [m/s]	9.4 – 41	9.4 – 41

* At 14,600 min⁻¹, UTL module, 4 M, water



Module ULTRA-TURRAX® UTL
Single stage module for homogenizing emulsions and suspensions



Module DISPAX-REACTOR® DR
3-stage disperser for fine emulsions and suspensions.



Module Colloid mill/cone mill MK/MKO
Wet milling with an adjustable gap milling tool. Emulsification (MK) and deagglomeration (MKO) of viscous products.

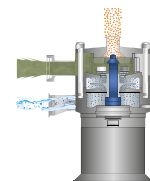

Module CMX
Lump and dust-free processing of powders and granules into liquids.



Module MHD
Continuous inline proportional incorporation of powders into liquids.



Module DBI
2-stage dispersion and pumping of solids and liquids

Application Information

Industry: Electronics industry
Application: Paste manufacture
Final product: Lithium ion batteries

Process type: Continuous, inline, single-pass, mixing — dispersing

Previous Processing Procedure

Batch processing with a planetary mixer.
High energy usage and manual work effort.

Basics

The production process for the cells of lithium ion batteries starts with the production of a paste for coating metal foils made of aluminum or copper. The ingredients vary depending on whether the electrode is an anode or cathode. However, the basic manufacturing process is similar. The ever increasing demand, finer raw materials and increasing quality requirements require new production methods that are more economical instead of the traditional batch mixer and, optionally, also allow a continuous process.

IKA® Solution

The pilot plant is used in recipe development and provides an exact simulation of the process technology in production. A solvent is placed in a storage tank. This is fed into the MHD in defined quantities via the metering pump. At the same time, the binder is dispensed using a powder dosing device. The MHD disperses and dissolves the powder in a recirculation process or in a single pass. The viscous binder solution then serves as a basic liquid. The required proportions of solids to improve conductivity and the active powder itself are dispersed in this basic liquid. The goal is to produce a homogeneous final product with a consistently stable viscosity at a low level of heating. Some ingredients require careful treatment in order to not destroy the structure. For this type of solids, a dispersion process in a single pass with the MHD offers the best compromise between homogeneous dispersion, lowest possible heat input and high production output. To ensure the best product quality, the premixed product can be moderately sheared once again in a second step with an MKO cone mill in order to guarantee that the final product is completely free of agglomerates. A cooling device, connected to the double casings of the dispersion unit and the storage tank, is used to maintain the maximum product temperature. A tubular heat exchanger can also be used to simulate fully continuous processes. The plant can be controlled manually on site or remotely via a PC. The labworldsoft software is used to ensure the exact reproducibility of the processes and to record the process parameters in each test.





Included

- > magic LAB® MHD
- > magic LAB® MKO
- > Liquid metering pump
- > Solids dosing system
- > Piping
- > Instrumentation
- > Software
- > Cooling system

Input Materials

- > Water
- > CMC
- > Carbon
- > Graphite
- > NMP
- > PVDF
- > Carbon

Customer Benefit

- > Automation with a high degree of flexibility for the recipe
- > Flexible production quantity, depending on current requirements
- > Product quality independent of operator skills
- > Minimized material loss and cleaning requirement
- > Small space requirement



IKA® Kneading Machines

Kneading machines are used for processes where high-speed tools would lead to huge temperature increases in the product. The product's characteristics, such as viscosity, cause a high shear even at low speeds. Accordingly, the drive systems and tools are designed for low speed and high torques.

Conterna HKC | Continuous Kneading Machine

The HKC kneading machine can mix liquids with solids (powders or granules) to a highly viscous product in a continuous process with no dust emissions.

The core element of a continuous kneading system is the Conterna kneading machine. This is fed with proportional quantities of the ingredients that are to be mixed, which are then mixed and homogenized in the working chambers, enabling a final product to be created in one single pass.

The throughput is determined by the dosing devices that feed in the ingredients. The mixing quality and the energy input depend on speed, tools and the time spent in the machine.

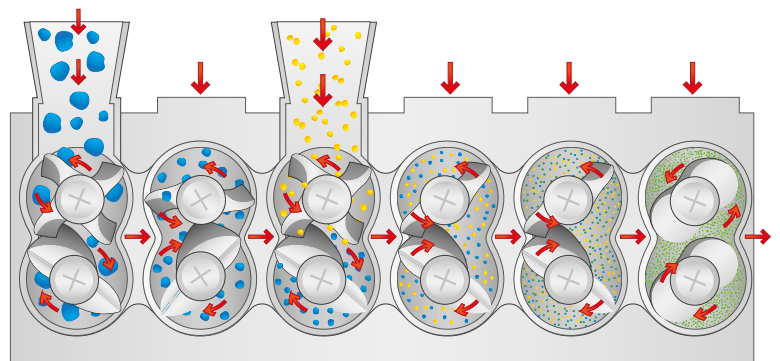

The CONTERNA is a continuous operation multi-chamber kneading machine patented throughout the world. The standard version has six horizontal processing chambers arranged in sequence, each powered by a frequency controlled hydraulic or electric drive. All six chambers are arranged together in a block but, depending on the application, systems with different numbers of chambers can also be used. Liquids and solids are usually introduced into the first chambers, but can also be added later. The product is discharged from the last chamber. This is equipped with a special tool for product discharge. Discharge takes place via a simple discharge nozzle or, optionally, discharge systems connected by a flange; for example, a gear pump or extruder. Shaping tools, such as dies, or granulation equipment are often used next. For temperature control using a heat transfer medium, the kneading chamber block has a separate double jacket at both the top and the bottom, as well as direct temperature control of the kneading blades.

Conterna | Technical Data



Speed adjustment



Ex-protected



IKA® HKC 6/2,0

	HKC 6/2	HKC 6/5	HKC 6/10	HKC 6/25	HKC 6/50	HKC 6/125
Technical Data						
Throughput [kg/h]*	10 – 80	20 – 200	70 – 400	120 – 1,000	200 – 2,000	500 – 4,000
Drive power per chamber [kW]	3	4	7.5	11	22	45
Drive power in pumping stage [kW]	1.5	1.5	2.2	4	11	15
Chamber volume [l]	2	5	10	25	50	125
Speed of upper DUPLEX blade [min ⁻¹]	5 – 25	4 – 20	3 – 15	3 – 15	2.5 – 13	2.5 – 12
Speed of lower DUPLEX blade [min ⁻¹]	10 – 50	8 – 40	6 – 30	6 – 30	5 – 26	5 – 24
Speed of upper Highvisc blade [min ⁻¹]	0.5 – 5	1 – 80	0.75 – 7	0.75 – 6	1 – 6.5	1 – 5
Speed of lower Highvisc blade [min ⁻¹]	1 – 10	2 – 16	1.5 – 14	1.5 – 12	2–13	1 – 10
Dimensions (L x W x H) [mm]**	1600 x 1480 x 1600	1600 x 1550 x 2000	1750 x 1600 x 2600	2600 x 1900 x 3600	3200 x 2200 x 4490	4300 x 2950 x 6100

* Depending on the product characteristics

** Dimensions with hydraulically extendible chambers and extruders

Application Information

Industry: Solar industry

Application: Silicon manufacture

Final product: Graphite mixing

Process type: Continuous, inline, single pass, mixing — dispersing

Previous Processing Procedure

Kneading in a batch operation

Basics

In wafer production e. g. for solar photovoltaic systems ingots are grown from silicon melt in special equipment. Due to the extremely high temperatures and the requirement to not contaminate the silicon, components made of graphite are, among others, used for these apparatuses. In order to produce these graphite components, an original shape to semi-finished products is necessary. The solid particles are homogeneously mixed with a binder at high temperatures in the range of about 200 ° C.

IKA® Solution

For the mixing process, a continuous multi-chamber kneading machine of the type HKC 12/50 is used. It produces a homogeneous product in one pass with an approximate throughput rate of 1,200 kg/h through 12 chambers, each containing 50 liters. The liquid component; coal, is first conveyed as a granulate from bulk bags on bucket elevators into big melting pots. There, the material is liquefied by heat and agitators and then transferred to the buffer tank. The continuous dosing into the HKC is done by a means of a displacement pump. The solid is a graphite blend of different grain sizes. The individual fractions are mixed in a batch and then continuously heated to processing temperature in a heating spiral. The powder mixture is proportionate to the volume and continuously dosed into the HKC by means of a heatable, gravimetric screw feeder. The components are mixed by the shearing of the kneading blades and conveyed from chamber to chamber. Total chamber volume and flow rate results in a theoretical residence time of approximately 30 minutes. The plant is highly flexible for adaptation to individual product variants without modification of the machine configuration. This is possible due to the ability to influence process parameters in the individual chambers. After discharge, the product is comminuted, cooled in a cooling screw and molded by a dry milling process in pressing for semi-finished products. All equipment and piping involved in the mixing process are heated with a central thermal oil system.



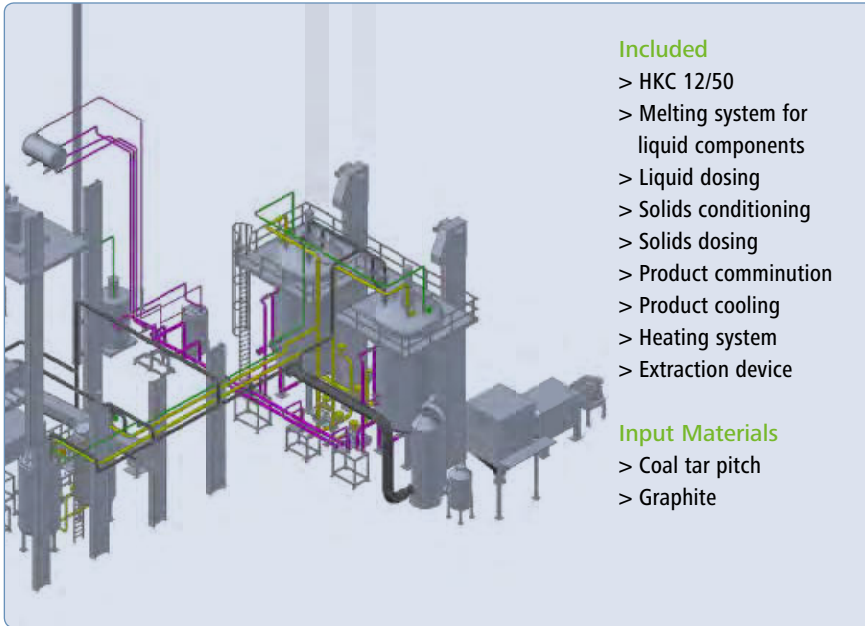

- Customer Benefit**
- > Consistent product quality
 - > Suitable for large concentrations of solids
 - > Low operator effort
 - > High level of flexibility for adjusting the product parameters when switching products
 - > Precise temperature control
 - > No interruption of production as a result of time-consuming cleaning work
 - > Fully automatic production with process control system operating 24/7
 - > Lower total energy consumption as there are no heating/cooling down cycles

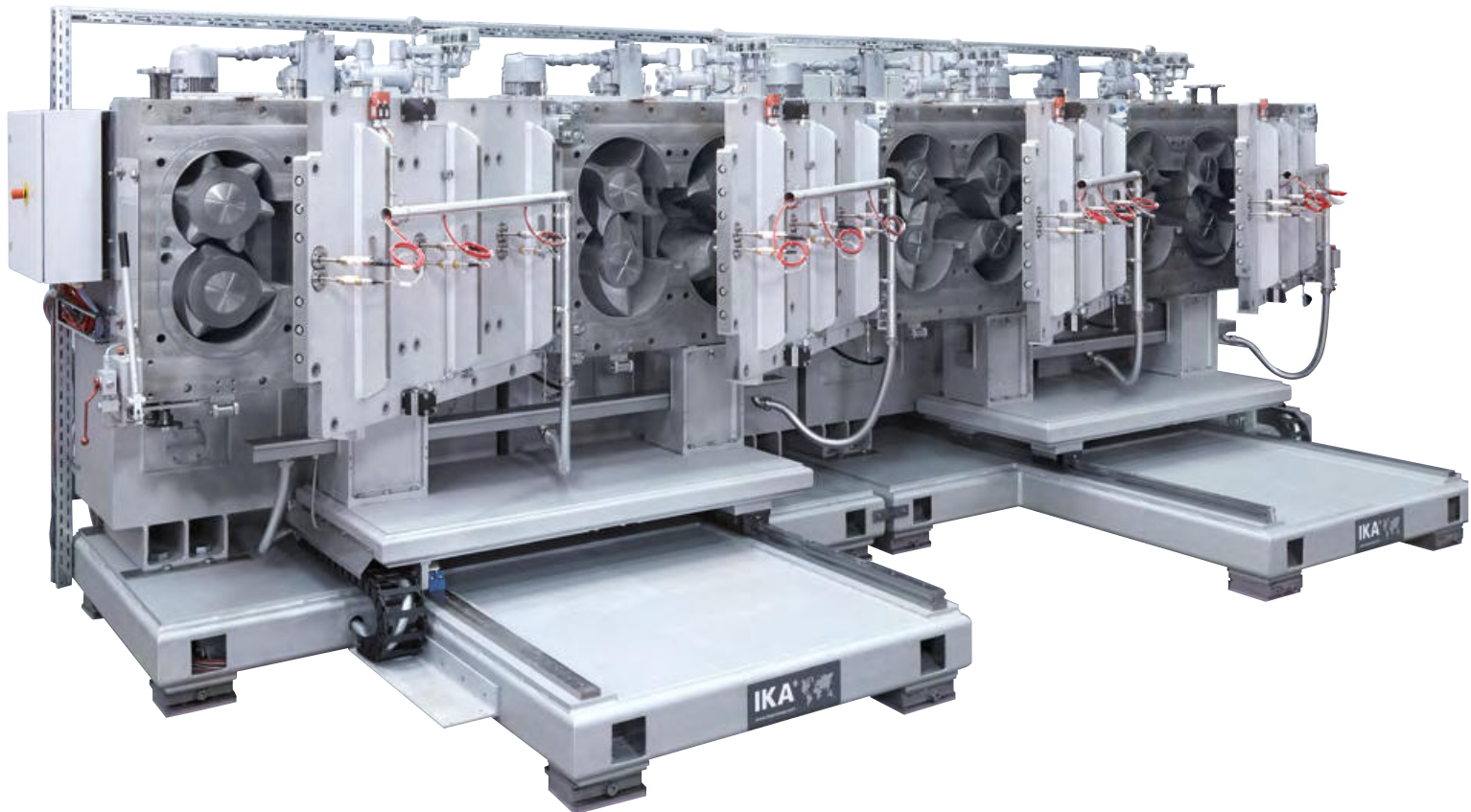

Control System | Process Control System

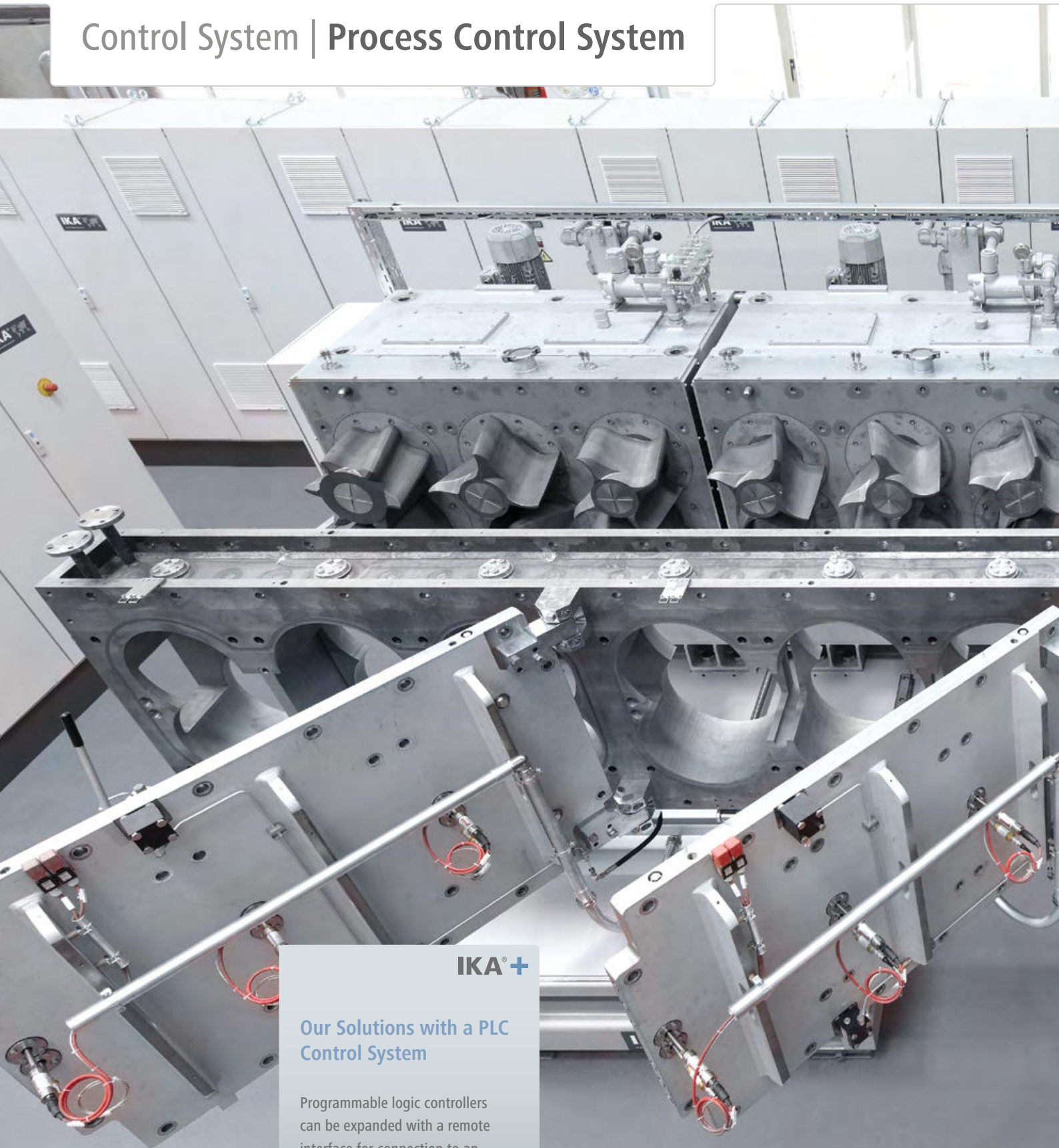

IKA®+

Our Solutions with a PLC Control System

Programmable logic controllers can be expanded with a remote interface for connection to an external system.

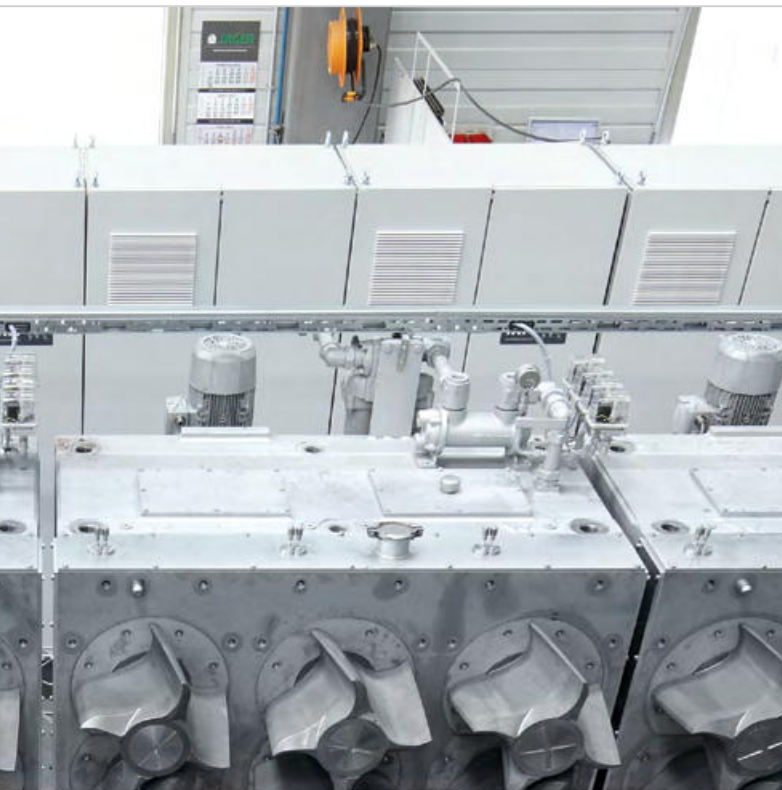

The IKA® process control system makes it easy to adjust and check recipes and all the relevant process parameters.



The electrical control system operates via an HMI (Human Machine Interface) and gives you the following options:

- > Manual control of the components using the touch screen
- > Limit value specification and monitoring
- > Alarm management incl. history memory
- > Safety locks
- > Trend function
- > Option to change language

Automation

Our IKA® machines and systems can also be delivered with an electrical control system to meet your specific requirements. You can choose from different degrees of automation: from simple on/off control for a mixing machine, to the control of all components in a production plant, fully automated recipe management and complete batch documentation. The user-friendly design of all control panels allows users to quickly become familiar with their operation.

If operation is via a process control system (PCS — with industrial PC), fully automated control of all components is provided. Different automation programs can be saved or loaded by accessing hard drives or other media. In addition to data security, this also allows programs or parts of programs to be transferred to other machines of the same type. All target and actual values over a certain period can be recorded graphically and stored. Batch management can also be integrated, enabling the data for each individual batch to be stored. Alarms are displayed and stored in plain text. Alarms can also be filtered, displayed and sorted by time, plant component and number.

SPP | Cost-efficient Batch Mixing System

IKA® +

The IKA® Standard Production Plant is a **state-of-the-art, yet cost-effective mixing system** for all basic mixing and dispersion technology operations.

The IKA® Standard Production Plant is available in **eight sizes** for volumes ranging from 25 up to 4,000 liters.

Vessel Cover

The Standard Production Plant is equipped with a vessel cover tilting device. This enables the cover with agitator to open to a 90 degree angle.



Funnel

for adding solid and liquid additives

Mixing Vessel

The unique conical shape of the vessel bottom enables complete discharge — even for highly viscous products.

Recirculation Loop

Large pipe with 2-way flap valves and clamp connections

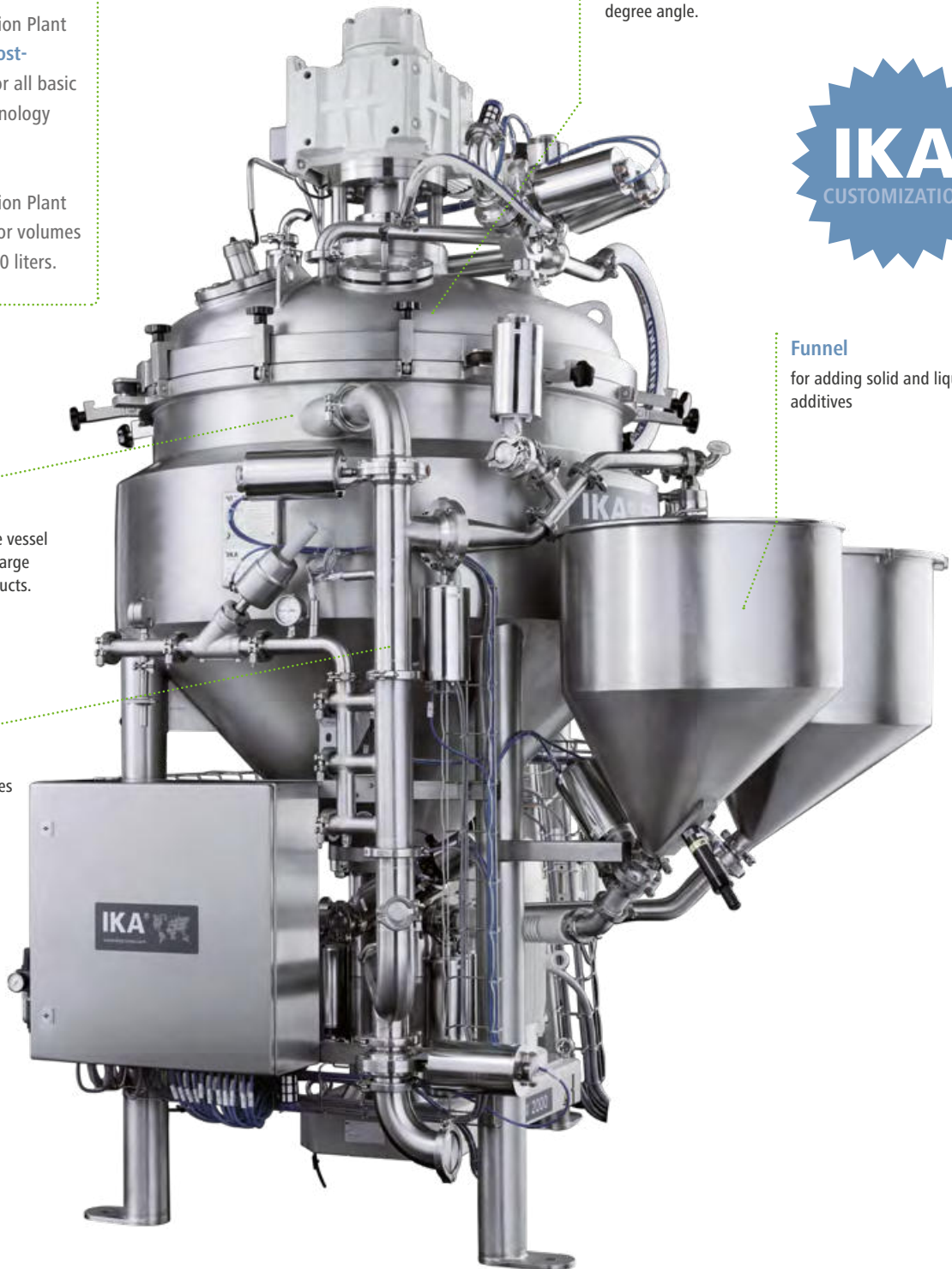

Technical data

IKA®+

- > Small minimum capacity
- > Low installation height
- > Flexible configuration



Speed adjustment



Food Grade



Cleaning in Place



Pharma Execution



Sterilization in Place



Ex-protected



SPP 100



SPP 500

Standard Production Plant	SPP 25	SPP 50	SPP 100	SPP 250	SPP 500	SPP 1000	SPP 2000	SPP 4000
Technical data								
Total connected load [kW]	5	6	9	10	23	25	50	55
Mixing vessel								
Min. useable volume [l]	8	15	30	75	150	300	600	1,200
Max. useable volume [l]	25	50	100	250	500	1,000	2,000	4,000
Dimensions (agitator)								
Height (closed cover) [mm]	1,350	1,480	1,720	2,000	2,670	3,050	3,635	4,260
Height (open cover) [mm]	1,520	1,695	1,990	2,460	3,085	3,760	4,500	–
Width (open cover) [mm]	1,070	1,220	1,370	1,705	2,080	2,935	3,500	2,600
Depth [mm]	800	860	1,080	1,250	1,350	1,765	2,200	2,600

Master Plant MP | Perfection in detail

IKA®+

- > Counter-rotating agitator for highest viscosities, **inner agitator can be heated/cooled**
- > The complete plant can be **sterilized with steam (SIP)**
- > **CIP-cleaning**, for which the DBI 2000 serves as pump and feeds the rotating spray nozzles



Connections

For vacuum, compressed air or funnel (additives)

Alternative

Heatable or coolable spiral agitator



Oposing agitators with movable scrapers and a heatable or coolable inner agitator

System Design

completely enclosed in stainless steel

Human-machine-interface (HMI)

with touch-screen monitor

Funnel

for incorporation of solids and liquids



Dispersing Machine

The high-performance dispersing machine DBI ensures high quality, stable emulsions and suspensions.

Technical data



Speed adjustment



Food Execution



Cleaning in Place



Pharma Execution



Sterilization in Place



Ex-protected



MP 10



MP 4000

Master Plant	MP 10	MP 25	MP 50	MP 100	MP 200	MP 500	MP 1000	MP 2000	MP 4000
Technical data									
Total connected load [kW]	5	7	8	12	13	31	35	70	80
Mixing vessel [l]	13	32	65	130	260	650	1,350	2,600	5,200
Useful volume [l]	10	25	50	100	200	500	1,000	2,000	4,000
Working pressure in the vessel [bar]	-1 to 2.5	-1 to 2.5	-1 to 2.5	-1 to 2.5	-1 to 2.5	-1 to 2.5	-1 to 2.5	-1 to 2.5	-1 to 2.5
Max. temperature in the vessel [°C]	150	150	150	150	150	150	150	150	150
Dimensions									
Height (closed cover) [mm]	1,065	1,637	1,817	2,305	2,421	3,315	3,749	4,951	5,425
Height (open cover) [mm]	1,515	2,086	2,417	2,950	3,376	4,615	5,499	7,051	7,865
Width [mm]	635	850	850	1,215	1,215	1,650	1,650	2,210	2,210
Depth [mm]	661	1,010	1,010	1,407	1,407	1,900	1,900	2,710	2,710

IKA® offers more

Details can be found
in our product brochures
or online at
www.ikaprocess.com

Vacuum Drying and Mixing



Pilot Systems

magic PLANT —
pilot-scale process
system



IKA® Laboratory & Analytical Equipment

IKA® is the indisputable leader in the world market for laboratory technology. Numerous innovations are evidence of the growing momentum within the company.

Magnetic stirrers, agitators, dispersers, shakers, mills, rotary evaporators, calorimeters, temperature control instruments and laboratory reactors make up the laboratory and analytical technology product range.

Batch Mixers

Batch processing equipment for dispersing and stirring



Dry Mills

Impact and cutting mill for dry material | Pilotina
Deagglomeration of solids | CONIKA



High Pressure Homogenizer

For applications where particle sizes in the nano range have to be achieved



IKA® offers more



Service | First-rate quality from initial consultation to full scale production

From the initial planning stages to final product realization, IKA® technology and services is with you each step of the way by offering a multitude of services:

- > Designing complete production plants
- > Performing test runs when developing new products
- > Planning and implementation of mechanical, electrical and pneumatic installations
- > Commissioning, including a test processing and training the operating personnel
- > Qualification

After project completion, our experienced engineers, electricians, chemists, application technicians and assemblers will be available to assist you with:

- > Technical advice for questions concerning operation, process and maintenance of IKA® machines and plants
- > Spare parts service
- > Repair service
- > Modification
- > Upgrading



Qualification

IKA® machines and units are designed to be suitable for use in the pharmaceutical industry.

According to GMP guidelines, pharmaceutical companies are required to validate processes that influence product quality. The applied machines and plants are subjected to a severe qualification process. During this qualification it is tested and documented that the pre-specified functionality is achieved. As early as in the planning stages, IKA® machines and units are designed to be suitable for use in the pharmaceutical industry. IKA® will provide the necessary documentation and, if desired, will conduct the design, installation and operation qualification together with you.



Test Center | From Idea to Solution

The IKA® pilot plant station consists of a vast array of different machines and plants as well as measuring and analytical devices. The pilot plant trials have influenced the concept and design of many of our machines and their tooling.

Searching for a suitable machine for your application?
At IKA® pilot plant station you can test out several mixing systems with a variety of tools. Our chemical engineers look forward to assisting and advising you during and after the trials. This way, an optimal solution for your specific mixing task can be determined.



Subject to technical changes
Details not binding for delivery.
Pictures may show accessories or
features that are optionally available
at extra charge.

IKA®+

Find out more

For further information on
IKA® and IKA® products,
please visit our website

www.ikaprocess.com

202002_Plants_IWS_EN_94000179



IKA® Worldwide

USA

IKA®-Works, Inc.
Phone: +1 910 452-7059
process@ikausa.com

China

IKA® Works Guangzhou
Phone: +86 20 8222 1771
Sales-Proc@ika.cn

Malaysia

IKA® Works (Asia) Sdn Bhd
Phone: +60 3 6099-5666
sales.process@ika.my

India

IKA® India Private Limited
Phone: +91 80 2625 3900
process@ika.in

Japan

IKA® Japan K.K.
Phone: +81 6 6730 6781
info@ika.ne.jp

Brasil

IKA® do Brasil
Phone: +55 19 3772-9600
info@ika.net.br

Korea

IKA® Korea. Ltd.
Phone: +82 2 2136 6800
info@ika.kr

Vietnam

IKA® Vietnam Company Limited
Phone: +84 28 38202142
sales.proc-vietnam@ika.com

United Kingdom

IKA® England Ltd.
Phone: +44 1865 986 162
sales.english@ika.com



IKAworlwide | #lookattheblue

IKA®-Werke GmbH & Co. KG
Janke & Kunkel-Str. 10
79219 Staufen
Germany

Phone +49 7633 831-0
Fax +49 7633 831 907

process@ika.de
www.ikaprocess.com

IKA® German technology