

MICROTRAC

a **VERDER** company



CAMSIZER X2+



PARTICLE ANALYZER

**PARTICLE SIZE AND SHAPE CHARACTERIZATION
BY DYNAMIC IMAGE ANALYSIS**



1974

MICROTRAC launches the first commercial laser diffraction analyzer, MICROTRAC Model 7991.

1987

Rollout of the high-precision gas adsorption instrument **BELSORP 28** by MicrotracBEL.

1998

Retsch Technology develops the **CAMSIZER** and its patented dual camera system.

2003

Premiere of the catalysis investigation system **BELCAT** by MicrotracBEL.

2007

Debut of MICROTRAC's **BLUEWAVE** laser diffractor that uses real blue lasers for highest resolution and sensitivity.

2011

Introduction of **CAMSIZER XT** with optional modules for wet and dry measurement.

2013

MicrotracBEL introduces the multi-sample **BET** surface area measurement system, **BELSORP MR6**.

2018

Launch of the MICROTRAC **SYNC**: laser diffraction and dynamic image analysis combined in one instrument.

2020

Merging of Retsch Technology, MICROTRAC & MicrotracBEL into MICROTRAC under the umbrella of Verder Scientific.

2023

Formulation, a recognized innovator in the field of Stability & Dispersibility analysis, is integrated into MICROTRAC.

Three Centers of Excellence

MICROTRAC: A SINGLE-SOURCE SOLUTION PROVIDER FOR PARTICLE CHARACTERIZATION

PARTICLE SIZE & SHAPE FOR PARTICLE ANALYSIS

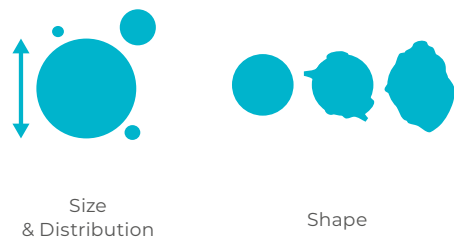

Size & Distribution

Shape

Our expertise in particle size distribution and shape analysis ensures optimal product quality control and supports advanced research efforts. At the core of our technology are **Dynamic Image Analysis (DIA) used on the CAMSIZER** and a combination of **Laser Diffraction (LD) and Dynamic Image Analysis used on the SYNC** systems. These two technologies cover all your needs for particle size analysis, ranging from 10 nm to 135 μ m, whether for dry or wet samples. Our unique size & shape analysis technology utilizes advanced light scattering, state-of-the-art cameras, and sophisticated computational software to deliver outstanding accuracy and repeatability.

COLLOIDS AND FORMULATIONS CHARACTERIZATION



Particle size

Zeta potential

Stability & Shelf-Life

When working with colloids or formulations, the three main parameters to consider are **particle size, zeta potential and stability/shelf-life**. At MICROTRAC, we address all these needs with our comprehensive technology platforms: **NANOTRAC, STABINO, and TURBISCAN**. Our solutions analyze these critical factors to ensure rapid R&D and Quality Control for the highest product quality. Utilizing **Dynamic Light Scattering (DLS), Static Multiple Light Scattering (SMLS), and Zeta Potential (ZP)**, our systems offer unique features such as non-dilution, high accuracy, and fast measurement enabling you to make fast decisions based on reliable data.

GAS ADSORPTION FOR MATERIALS CHARACTERIZATION

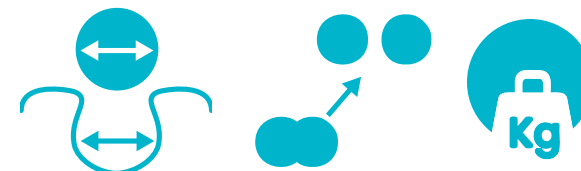

Surface Area & Pore size

Catalysis

Density

We offer advanced solutions for measuring surface area, porosity, and catalytic properties of materials. The MICROTRAC analyzers, celebrated for their precision in **gas and vapor adsorption measurements**, determine BET surface area and pore size distribution for both porous and non-porous materials. These analyzers employ cutting-edge gas adsorption technology and are widely used in various sectors, including Research and Development, Quality Control, and Quality Assurance. These tools are trusted worldwide, reflecting the renowned craftsmanship and quality of Japanese engineering, with comprehensive support provided by our competence centers in Japan (Osaka), Germany (Haan), USA (Newtown, PA) and France (Toulouse). The **BELSORP** and **BELPORE** analyzers are essential for achieving accurate gas and vapor adsorption analysis.

HIGH-RESOLUTION IMAGE ANALYSIS OF PARTICLE SIZE AND PARTICLE SHAPE

CAMSIZER SERIES

With the **CAMSIZER X2+** and **CAMSIZER 3D MICROTRAC** sets standards in **Dynamic Image Analysis**. Thanks to the unique two-camera principle, these instruments provide quick analyses with excellent accuracy and reproducibility over an extremely wide measuring range.

This makes the **CAMSIZERS** ideally suited for routine analysis as well as quality control applications. Thanks to powerful evaluation software which provides a multitude of valuable information and measurement parameters, the analyzers are also suitable for usage in R&D applications.

The **CAMSIZER XL** measures particles up to 135 mm and is engineered to work in rough industrial environments.

The **CAMSIZER S1** is an entry-level image analyzer suitable for many standard applications in quality control.

- ▶ **CAMSIZER X2+**
High-performance analyzer for powders and suspensions
- ▶ **CAMSIZER 3D**
With patented three-dimensional tracking technology
- ▶ **CAMSIZER S1**
Entry-level unit for Quality Control
- ▶ **CAMSIZER XL**
For large particles and rough environments.

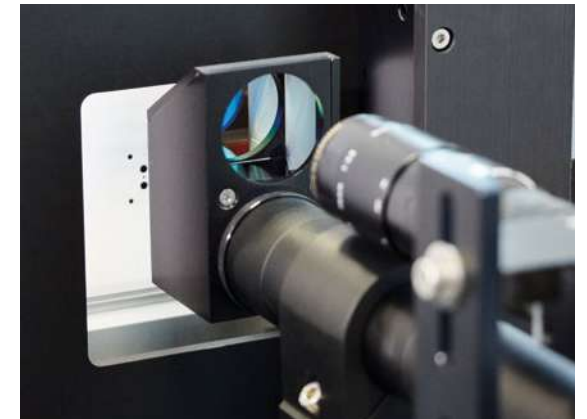
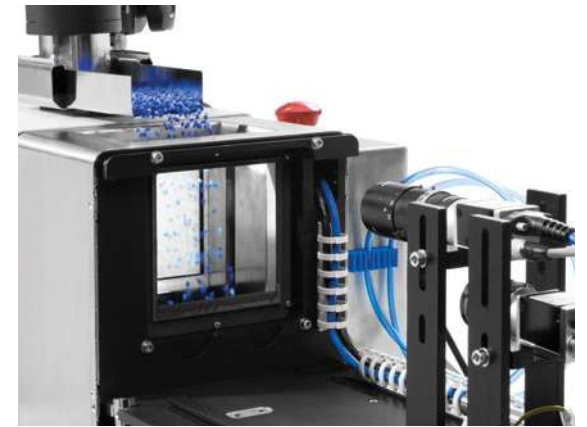

FLEXIBLE SIZE AND SHAPE ANALYSIS FOR HIGHEST REQUIREMENTS

CAMSIZER X2+



The **CAMSIZER X2+** is a powerful, extremely versatile particle analyzer with a wide measuring range that combines state-of-the-art camera technology with flexible dispersion options. Based on the principle of Dynamic Image Analysis (ISO 13322-2), the **CAMSIZER X2+** provides precise particle size and shape information of powders, granules and suspensions in a measuring range from 0.9 μm to 8 mm.

The **CAMSIZER X2+** produces a particle flow which is detected by an optical system with high resolution. Two ultrabright LED stroboscopic light sources and two high-resolution digital cameras achieve a frame rate of more than 420 images per second which are evaluated in real time by a powerful software.

Thus, the **CAMSIZER X2+** captures the images of hundreds of thousands to several millions of particles with highest accuracy within only 1 to 3 minutes. The **CAMSIZER X2+** provides a wide selection of particle information which allows for comprehensive and reliable characterization of the sample material. It is suitable for use in R&D as well as for routine tasks in Quality Control.

Advantages of MICROTRAC's PARTICLE ANALYZER CAMSIZER X2+

- ▶ Particle size and particle shape analysis from 0.9 μm to 8 mm with **Dynamic Image Analysis** (ISO 13322-2)
- ▶ Precise analysis of wide size distributions
- ▶ Excellent resolution for narrow or multimodal size distributions
- ▶ Detection of small amounts of oversized or undersized particles
- ▶ Fully comparable to sieve analysis and laser diffraction results
- ▶ A wealth of evaluation options (different size definitions, a variety of shape parameters, Particle Viewer, etc.)
- ▶ Outstanding reproducibility
- ▶ Measurement time 1 – 3 minutes, high sample throughput
- ▶ Modular “X-Change” system for dry and wet measurement
- ▶ Ultra-strong LEDs and high-resolution cameras for the clearest results
- ▶ Ready for AI-supported particle evaluation



DUAL CAMERA TECHNOLOGY

EXTREMELY WIDE MEASURING RANGE DUE TO DUAL CAMERA TECHNOLOGY

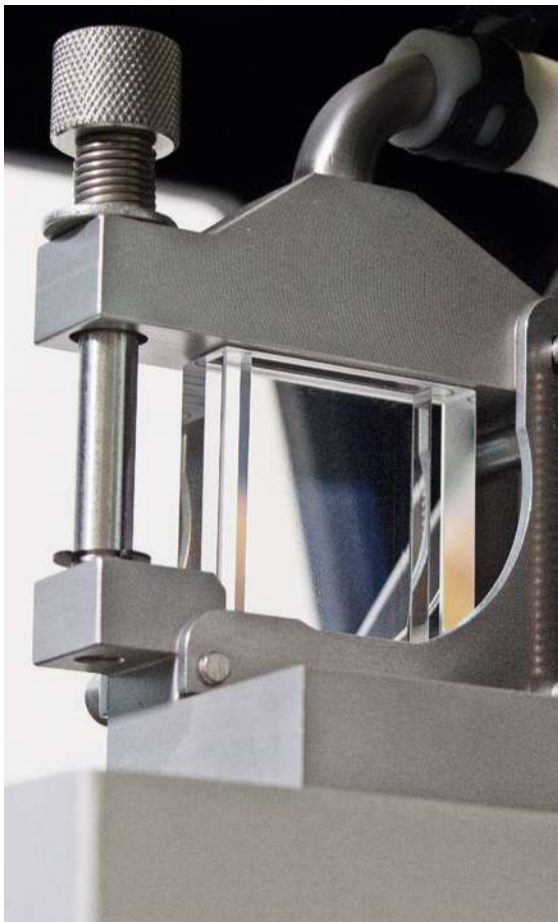

MICROTRAC's unique dual camera technology is a landmark in the development of Dynamic Image Analysis. By simultaneously employing two cameras with different magnifications, extremely wide dynamic measuring ranges are achieved. This is accomplished without hardware adjustments or modifications and without compromising accuracy.

The ZOOM camera analyzes fine particles with highest precision whereas the BASIC camera detects the larger particles with excellent statistics. A special algorithm combines the information provided by both cameras and delivers the exact size distribution in a possible range of more than three orders of magnitude!

This arrangement resolves a significant drawback of many image analysis systems that employ only one camera, e. g., microscopes. Such instruments either cannot correctly report the fine particles in wide size distributions, or the large particles are not captured due to the small field of view.



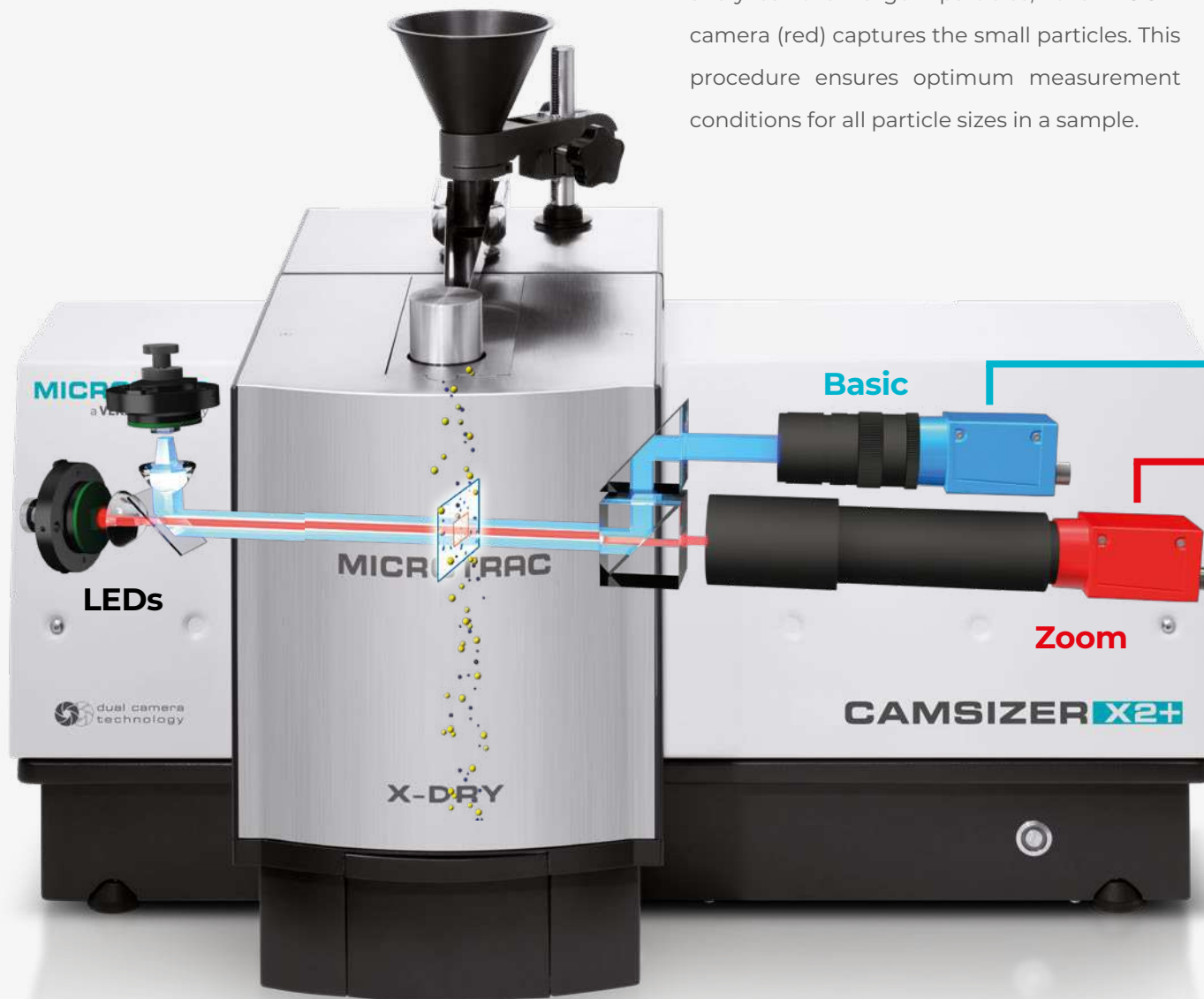

MEASUREMENT PRINCIPLE

Two cameras operate simultaneously during measurement: the **BASIC** camera (blue) analyzes the larger particles; the **ZOOM** camera (red) captures the small particles. This procedure ensures optimum measurement conditions for all particle sizes in a sample.

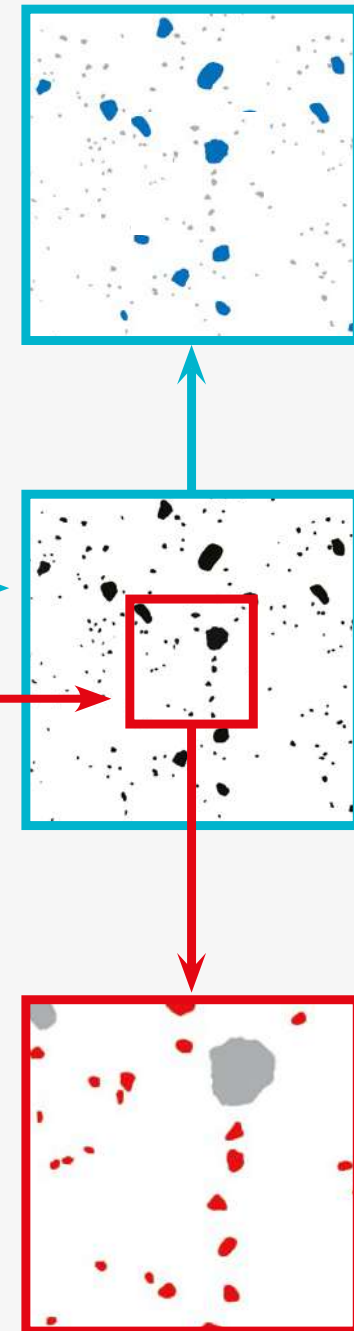

MODULAR X-CHANGE SYSTEM FOR MAXIMUM FLEXIBILITY

Correct sample preparation and dispersion of the particles before passing into the measurement zone are as important as the actual analysis. Particularly for fine powders which tend to agglomerate, sufficient dispersion is crucial to the reliability of the measurement results. Therefore, various modes of sample feeding help to achieve separation of the agglomerates without destroying individual particles. The **CAMSIZER X2+** offers three dispersion options:

I Dispersion by compressed air

The X-Jet module disperses the sample via a Venturi nozzle and is suitable for the effective analysis of powders. The actual measurement of the particles takes place in the air stream. Dispersion pressure may be set between 0 kPa and 460 kPa. This ensures optimum analysis conditions for all sample types.

I Dispersion by gravity

The X-Fall module is used for non-destructive measurement of sensitive samples in free fall to minimize particle breakage. The sample can be recovered after the analysis.

I Dispersion in liquids

The X-Flow module offers the option to analyze particles in a liquid. The suspension flows in a closed circle through a glass cell where the cameras record the particle images. The integrated ultrasonic unit further aids in the dispersion process.





MODULAR DESIGN FOR MAXIMUM FLEXIBILITY

The CAMSIZER X2+'s modular "X-Change" system offers **three alternative dispersion options**, permitting the selection of the **optimum method** for each sample type. The user may choose between wet dispersion with **X-Flow** or dry measurement either in free fall with **X-Fall** or in an air flow with **X-Jet**. The modules and cartridges are quickly and easily exchanged which makes working with the **CAMSIZER X2+** convenient and safe.

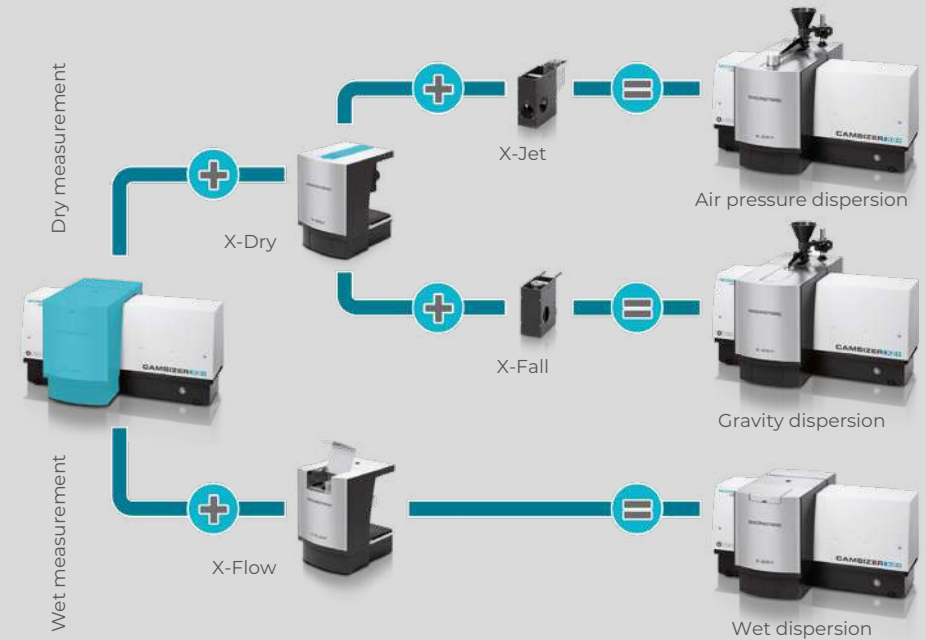

AIR PRESSURE DISPERSION WITH X-JET

Many materials tend to agglomerate due to surface forces. The X-Jet module effectively disperses the particles in an air flow while passing through a Venturi nozzle. The dispersion pressure can be set as required for individual particles. For sensitive granules, for example, reduced pressure ensures non-destructive measurement. After passing the measurement field, the sample is automatically removed from the analyzer by a vacuum cleaner.

- ▶ Pressure adjustable from 0 kPa to 460 kPa
- ▶ Effective dispersion, also for particles < 10 μm
- ▶ Gentle measurement of friable samples
- ▶ Quick analysis of large quantities
- ▶ Different nozzle diameters are available for larger particles or small sample volumes

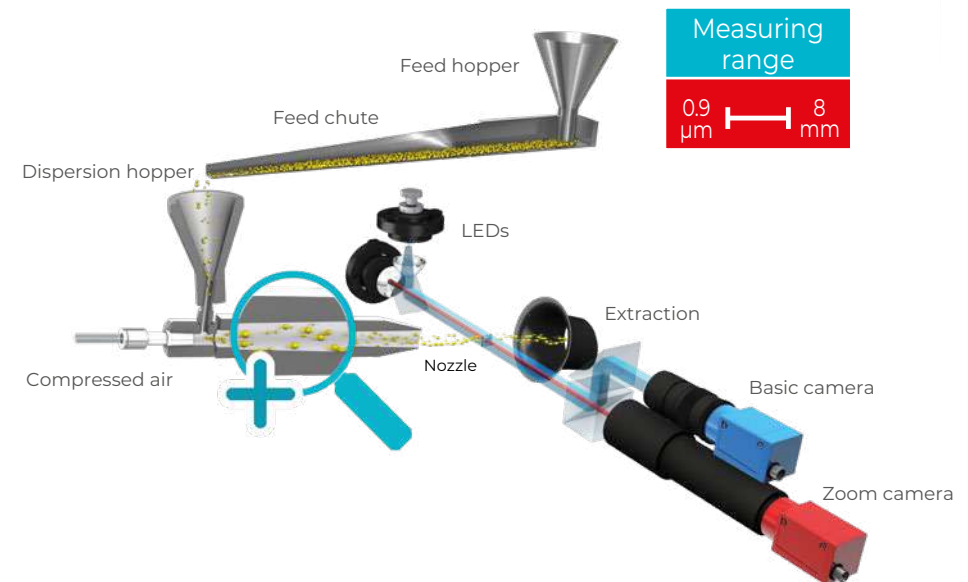

WET MEASUREMENT WITH X-FLOW

The wet module X-Flow analyzes suspensions in a size range from 0.9 μm to 1 mm. The sample moves within a closed loop from the dispersion bath to the flow cell where the camera system captures the particle images. X-Flow comes with an ultrasonic bath and strong centrifugal pump to ensure efficient dispersion. Suitable dispersion media are water, alcohol, and also nonpolar organic solvents.

- ▶ Analysis of suspensions and emulsions
- ▶ Effective dispersion with ultrasound
- ▶ Resistant to organic solvents
- ▶ Automatic filling and cleaning

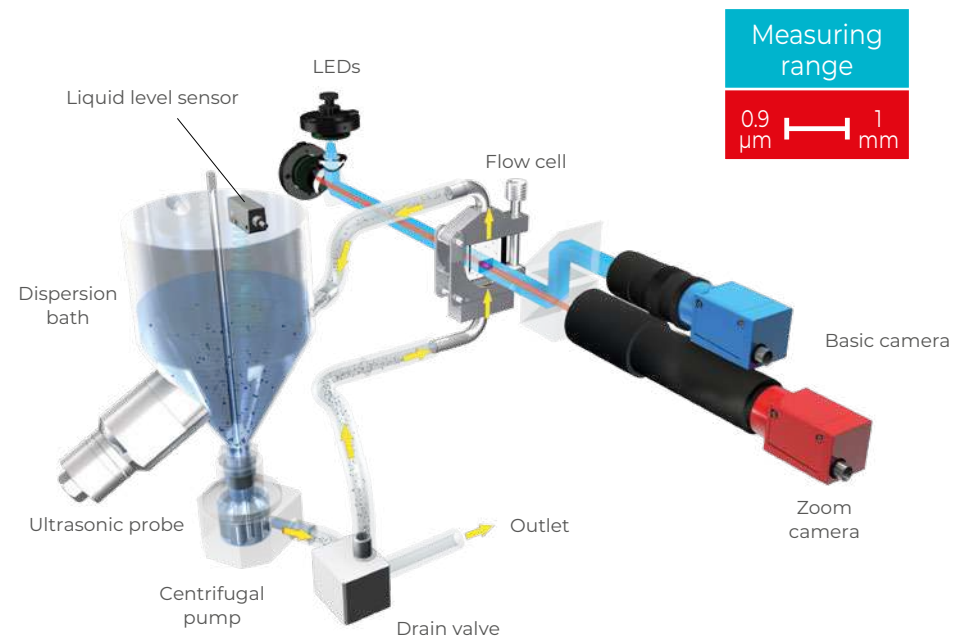

GRAVITY DISPERSION WITH X-FALL

Flowable, unagglomerated samples can be analyzed by using the X-Fall module. The measurement is non-destructive because the particles directly fall from a chute through the field of view. X-Fall is suitable for particle sizes up to 8 mm; the detection sensitivity for oversized grains is extremely high. In contrast to dispersion by air pressure, the sample can be recovered after the measurement with X-Fall.

- ▶ Gentle, contact-free measurement
- ▶ Analysis of particle sizes up to 8 mm
- ▶ Complete sample recovery

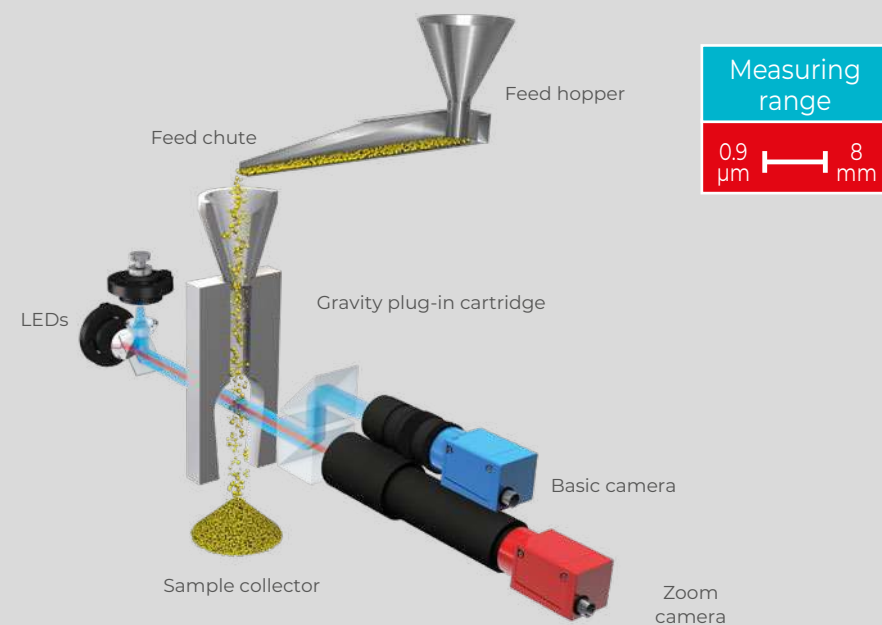

A WEALTH OF ANALYSIS AND EVALUATION OPTIONS

All parameters at a glance: Dynamic Image Analysis provides comprehensive information about the sample material to be analyzed. The high-performance **DIMENSIONS** software package measures dozens of parameters from every single particle and presents the results in a clearly structured, standard-compliant measurement report. Functions like the comprehensive export option and the generation of synoptical tables or trend analyses are routine procedures.

Storage and automatic monitoring of predetermined product specifications are also part of the software. Password protection prevents undesired modifications of measurement settings. Hence, analyses may also be carried out by non-technical staff.

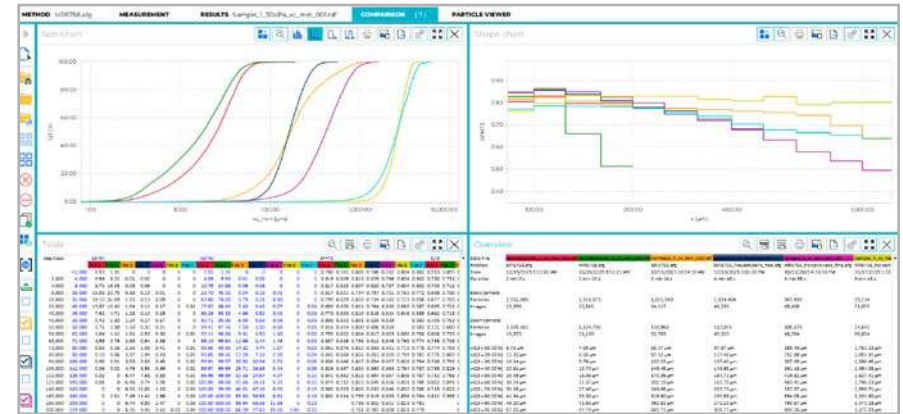

User interface of the **CAMSIZER** software

DETAILED EVALUATIONS WITH PARTICLE VIEWER

The strength of Dynamic Image Analysis is the evaluation of a vast number of particles in a very short period of time. The result after 1 to 3 minutes measuring time is usually based on hundreds of thousands to millions of single particles which guarantees a high statistical reliability. The software enables particle images to be saved and displayed in a consistent workspace, allowing users to locate particles with specific property combinations and gain detailed insights into the sample material's morphology. Further options provided by Particle Viewer include the creation of Particle Heatmap diagrams or subsequent filtering and advanced recalculation of complete data sets.

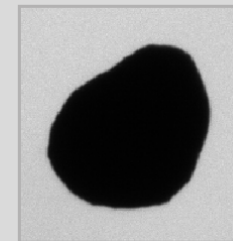

Sand sample with rounded grains



Sand sample with angular grains

ONLY IMAGE ANALYSIS PROVIDES INFORMATION ON PARTICLE SHAPE

Bulk material properties like density, flowability, compactibility, conveying characteristics and surface condition are influenced by particle shape. This makes these parameters a crucial process and quality indicator in many application areas.

Examples:

- | Angularity of abrasives
- | Analysis of broken fractions in granules
- | Detection of agglomerates
- | Analysis of the roundness of plastic or metal powder particles for Additive Manufacturing (direct influence on flowability and packing density)
- | Length and diameter of needle-shaped crystals
- | Analysis of the roundness of sand particles to evaluate the usability as construction material or proppant, or for geological examinations

Various parameters are available for shape quantification (see illustration on the left). These include width/length ratio (aspect ratio), circularity (calculated from area-to-perimeter ratio), symmetry, convexity, and compactness. Roundness is calculated from the curvature of the particles' corners.

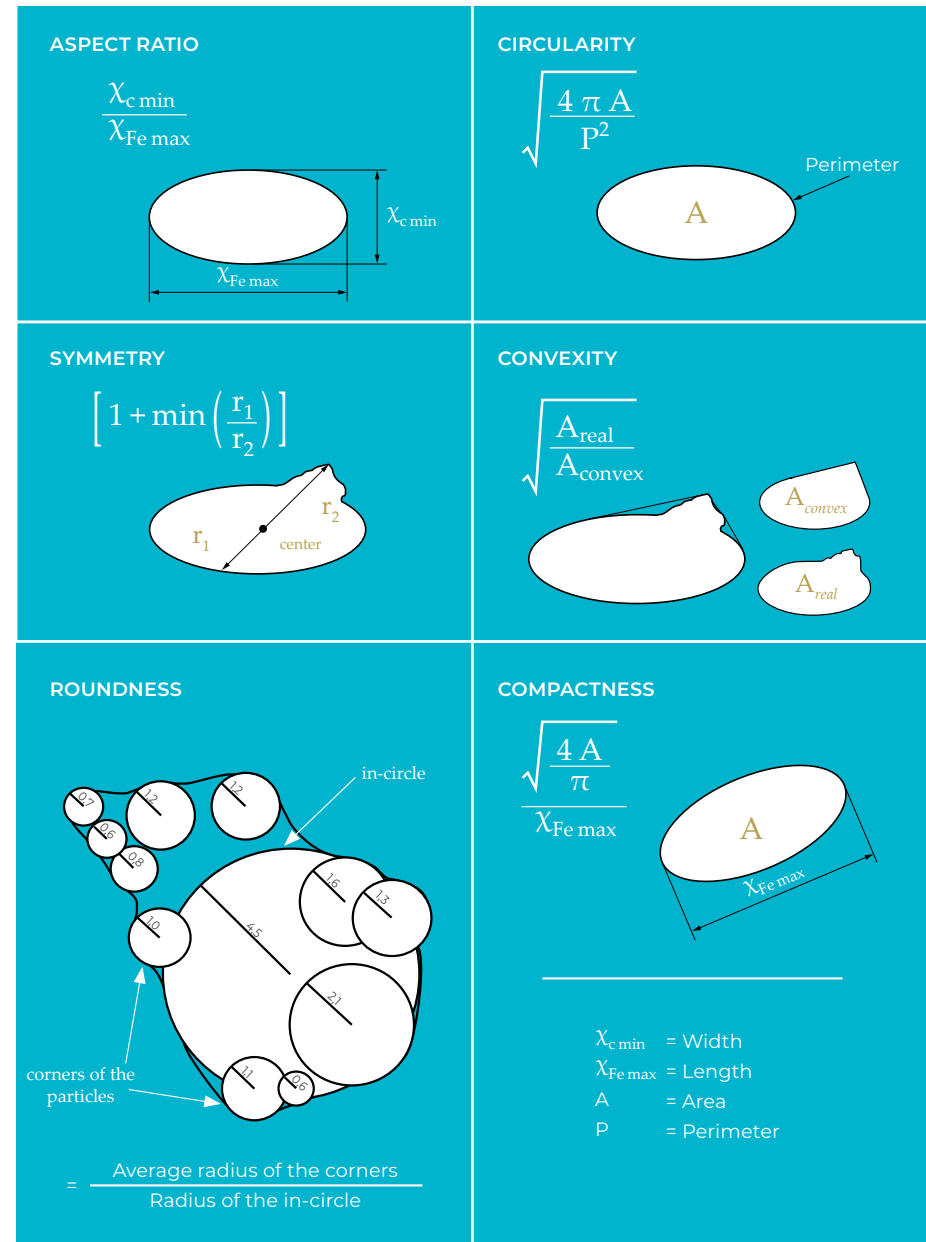

COMPARABILITY TO SIEVE ANALYSIS AND LASER DIFFRACTION

“Size” is only defined unambiguously for spherical particles: the diameter is identical in all directions and orientations. For non-spherical particles, however, the dimensions can vary strongly, depending on the orientation and direction of measurement. Traditional sieve analysis, for example, separates particles on a wire mesh sieve stack with different aperture sizes into fractions.

The smallest possible sieve aperture that a particle can pass is defined by the particle’s smallest projection area. Hence, sieve analysis measures particles in a preferential orientation and provides information which is mostly based on the width of the particle. Particle size analysis with laser diffraction relates all measuring data to the diameter of a spherical particle model. Only image analysis offers different size definitions which can be ascertained simulta-

neously. This makes the results comparable to those obtained with other techniques.

The outstanding strength of DIA is the possibility to measure width and length of a particle and to provide a size distribution based on these parameters. The particle width (red curve) can easily be compared to sieve analysis results.

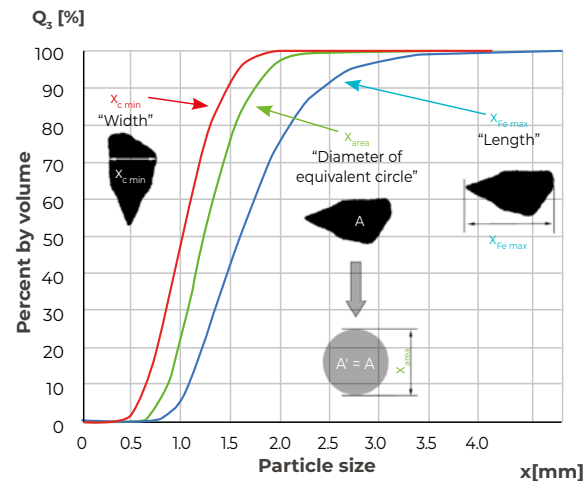

DIA may use different size definitions



AI POWERED PARTICLE CLASSIFICATION FROM IMAGES TO INTELLIGENT CLASSIFICATION

The **CAMSIZER** series combines **Dynamic Image Analysis** with AI Filters in the **DIMENSIONS** software to automatically classify particles in mixed samples. Based on large numbers of individual particle images, AI-assisted analysis enables reliable separation of different particle populations and provides statistically robust results.

AI Filters allow particles to be distinguished even when size distributions overlap, for example separating round particles from angular particles, desired product from contaminants, or intact particles from defects. Classification can be based on measured size and shape descriptors such as `xc_min`, width, thickness, Aspect Ratio (b/l), roundness, compactness, or transparency, or directly on particle image information, independent of predefined descriptors.

AI Filters can be applied during measurement or recalculated within seconds on stored data. Classified particles are displayed directly in the Particle Viewer, enabling immediate visual validation of each class and ensuring transparent, objective results with reduced operator influence.

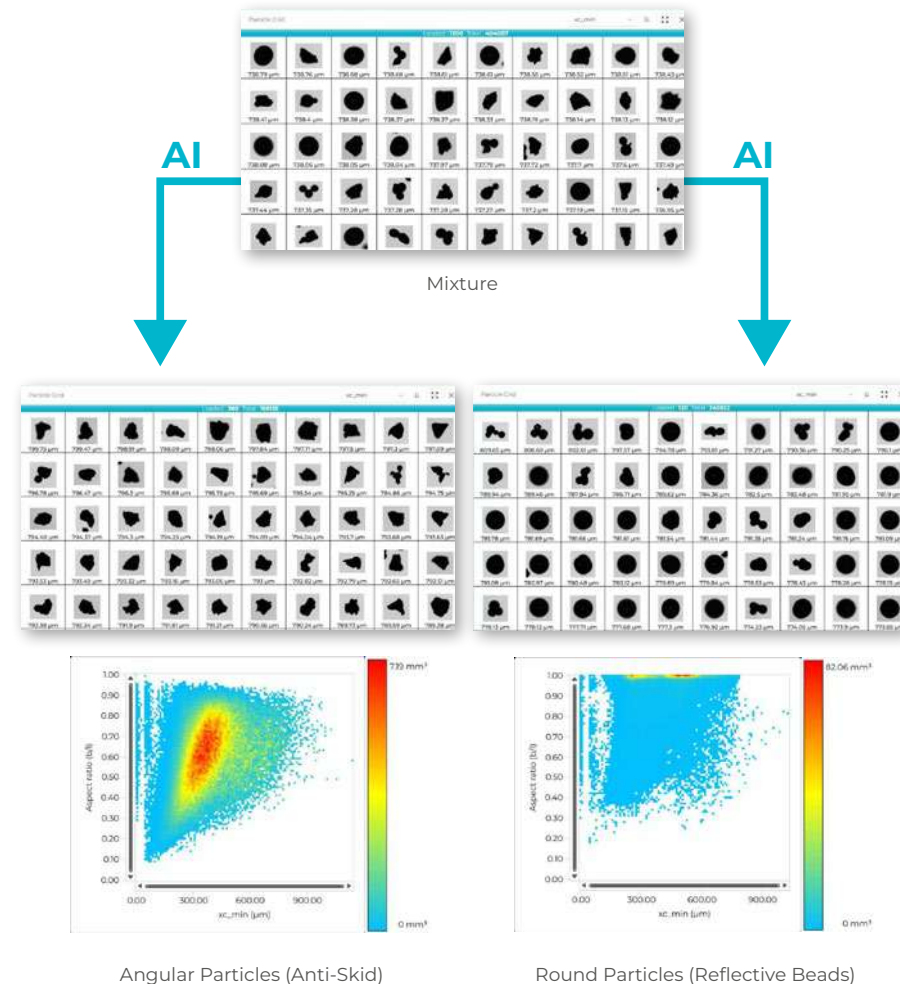

SMARTER QC, DEEPER INSIGHT FROM AI FILTERS TO QUANTITATIVE RESULTS

AI Filters in the **CAMSIZER** series do more than sort particle images — they enable advanced, class-specific evaluation. After classification, **DIMENSIONS** automatically recalculates size distributions and shape distributions separately for each particle class.

In addition, the software calculates the volume percentage of each class, providing direct quantitative information on component ratios, contaminants, or defective fractions. This supports robust quality control, batch-to-batch comparison, and reliable detection of small outlier populations such as agglomerates or oversized particles.

Typical applications include evaluating mixed materials, identifying shape quality tails, and quantifying foreign particles in powders, grains, pellets, or abrasives. User-trainable AI Filters can be adapted to specific materials and reused for routine QC or R&D, delivering higher productivity, deeper insight, and robust quality control from a single **Dynamic Image Analysis** measurement.

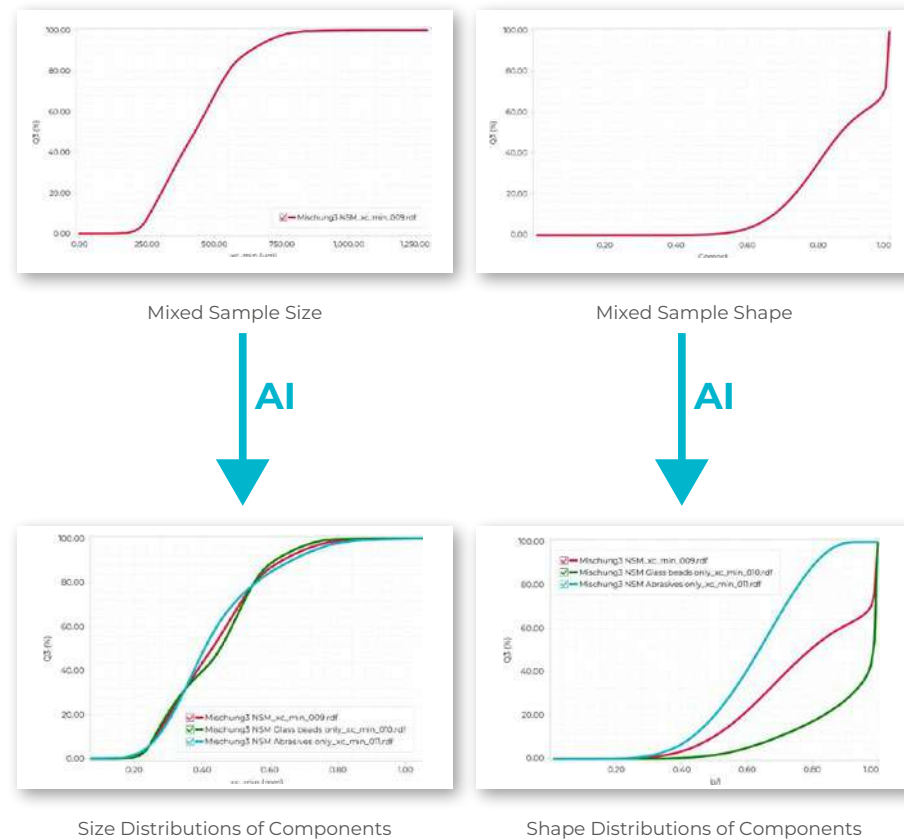



POWDER METALLURGY QUALITY ASSURANCE FOR ADDITIVE MANUFACTURING

The different techniques used in powder metallurgy require different material properties. For Additive Manufacturing (AM), for example selective laser sintering, a homogeneous particle size distribution and spherical particle shape are crucial. The example shows a range of **CAMSIZER X2+** analyses of various metal powders which are reliably characterized for their suitability to be used in powder metallurgical processes. Non-spherical, fused or broken particles are reliably detected and quantified. Analysis of metal powders with a mean particle size < 10 μm , which are utilized for Metal Injection Moulding (MIM), is also possible with the **CAMSIZER X2+**.

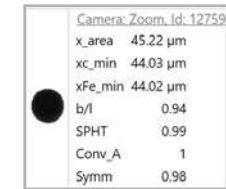
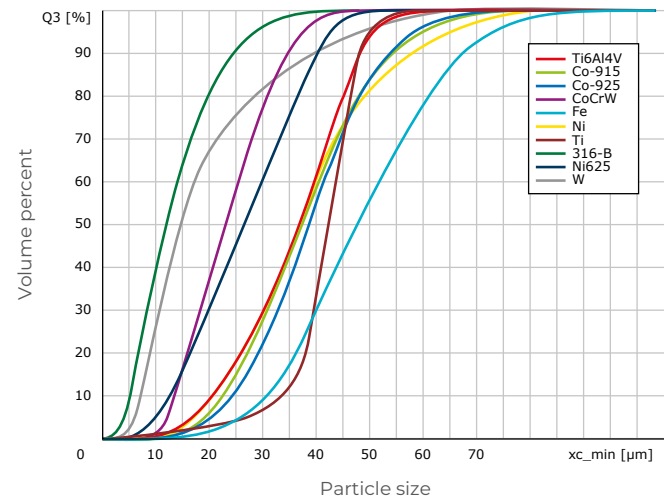
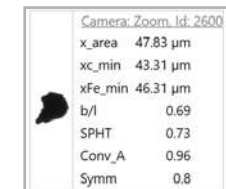

Image of a spherical metal powder particle



Irregular particles are reliably detected

COFFEE POWDER COMPARABILITY TO SIEVE ANALYSIS AND LASER DIFFRACTION

The particle size distribution of ground coffee determines the extraction properties and thus influences the taste. Different types of coffee production (filtered coffee, espresso, etc.) require different degrees of fineness. The size distribution of coffee powder may reach up to 2 mm, with a significant fine fraction. The **CAMSIZER X2+** analyzes this size range quickly and reliably.

The **CAMSIZER X2+** delivers results which are fully comparable to alternative measurement techniques by consideration of the suitable size definition. The results of sieve analysis correspond to the size definition x_{cmin} . Laser diffraction relates all measuring data to the diameter of an ideal spherical particle. Hence, the results best match the size definition x_{area} .

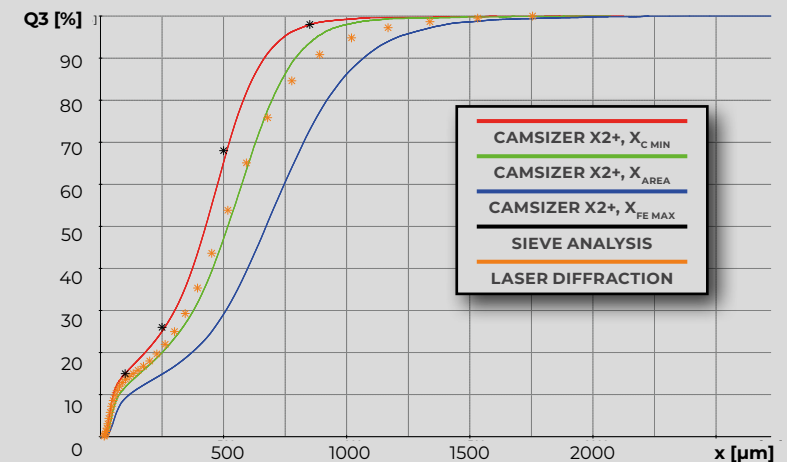

PHARMACEUTICALS & FOOD ANALYSIS OF GRANULES, ACTIVE INGREDIENTS AND EXCIPIENTS

The **CAMSIZER X2+** is ideally suited for particle size and particle shape analysis of a huge variety of pharmaceutical products. A typical application is the analysis of all kinds of pellets and spheres which are quickly and thoroughly measured in dry mode by using the X-Fall or X-Jet module. Thanks to the flexible dispersion options, fine crystalline or micronized active ingredients and excipients (like cellulose or citric acid) are easily and efficiently characterized. The software package **DIMENSIONS** fully supports operation according to the regulations of 21 CFR part 11. The example shows the results of measuring two granules with similar size but completely different shape.

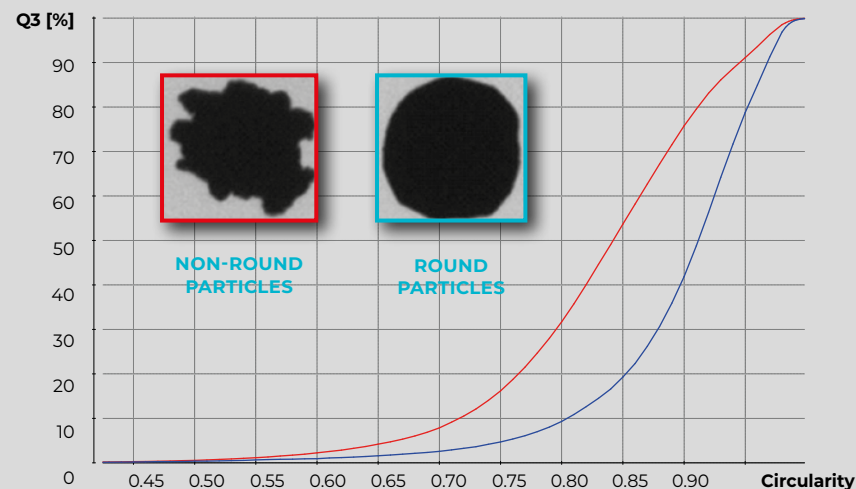

MINERALS & CONSTRUCTION MATERIALS RELIABLE DETECTION OF OVERSIZE GRAINS

The **CAMSIZER X2+** is suitable for measuring a variety of minerals and ceramic materials. High sample throughput, highest precision and sensitivity to the slightest variations in product quality make the **CAMSIZER X2+** the ideal instrument for quality control.

For many applications, reliable detection of small amounts of oversize particles is crucial. In this application example, a gypsum sample consisting of particles <100 μm was mixed with a few coarse particles (0.1 wt. %). These are precisely detected by the **CAMSIZER X2+**.

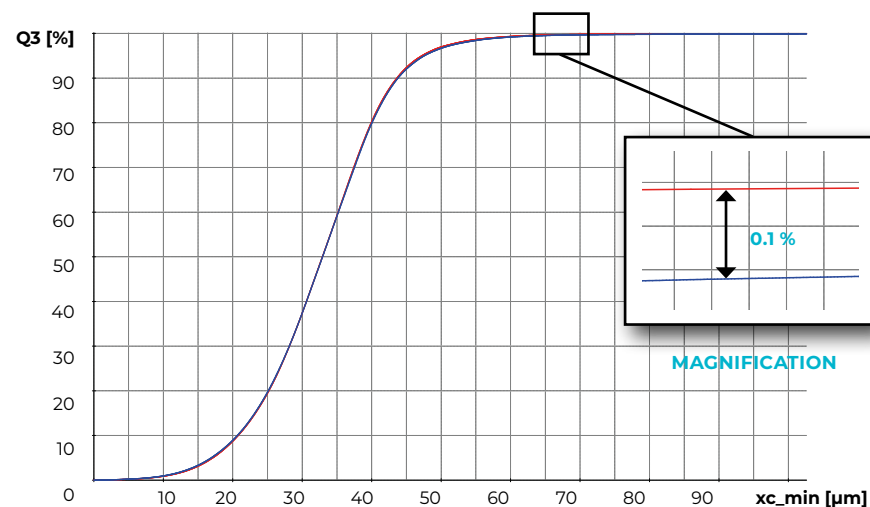

MICRO-ABRASIVES HIGH PERFORMANCE FOR SMALL PARTICLES

The X-Jet cartridge is the perfect choice for measuring fine powders precisely and reproducibly. The example shows a SiC micro-abrasive sample at the lower end of the **CAMSIZER X2+** measuring range. The size distribution lies between 1 μm and 12 μm . Thanks to the high depth of field, pulsed, ultra-strong light sources and short exposure times, these rapidly moving, micrometer-sized particles are reliably detected. The precisely defined fineness of the abrasive guarantees the optimum combination of abrasion and surface roughness.

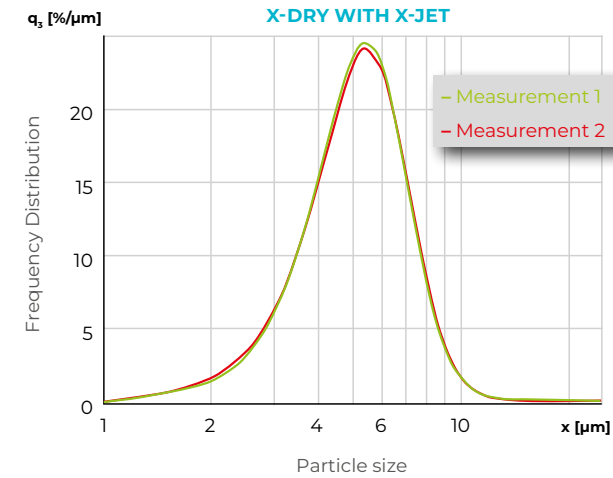

ACCESSORIES AND OPTIONS OPTIMUM CONFIGURATION FOR EACH APPLICATION

MICROTRAC offers a variety of hoppers and chutes (1) for special applications. Dispersion nozzles and cuvettes are available in different aperture sizes to ensure optimum conditions for each measurement (2). Calibration of the **CAMSIZER X2+** only takes one minute and can be carried out by using a high-precision reference reticle (3). A range of sample dividers produces representative subsamples or aliquots of powders, granulates and all kinds of bulk materials (4).

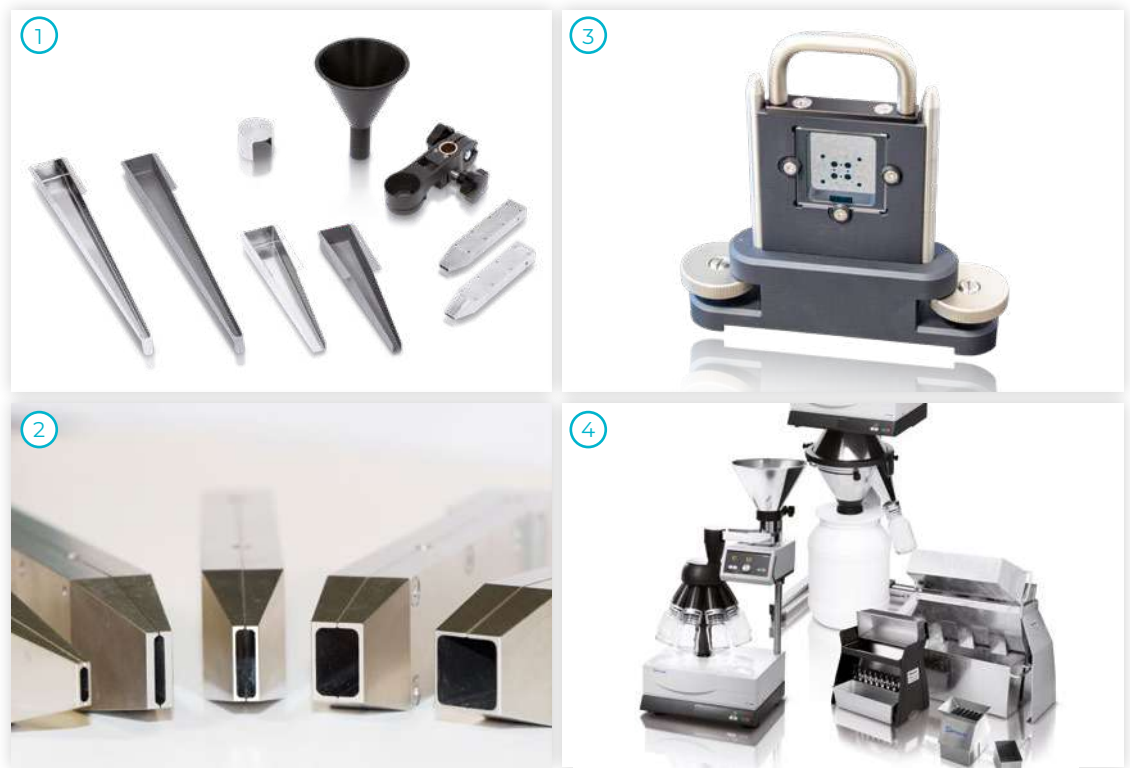



MICROTRAC

CAMSIZER X2+

TECHNICAL DETAILS

SPECIFICATIONS AT A GLANCE

The **CAMSIZER X2+** is CE-certified and complies with the relevant regulations and standards.

The vacuum cleaner is included in the delivery of the X-Dry module.

Measuring principle	Dynamic Image Analysis (ISO 13322-2)	
Measurement ranges	0.9 μm - 8 mm (dry analysis)	
	0.9 μm - 1 mm (wet analysis)	
Type of analysis	Dry and wet	
Measuring time	1 – 3 minutes (sample dependent)	
Sample quantity	20 mg – 500 g (material dependent)	
Number of cameras	2	
Camera performance	>420 images/sec.	
Image size	approx. 350 mm ²	
Digital Resolution	0.9 μm /Pixel	
Measurement parameters	Particle size	Smallest diameter, length, mean diameter etc.
	Particle shape	Aspect ratio (width to length), symmetry, sphericity, convexity etc., acc. to ISO 9276-6
Instrument data	Dimensions (H x W x D)	850 x 580 x 570 mm
	Weight (without PC)	50 kg
PC requirements	Quad-core PC incl. Windows T1, monitor, keyboard and mouse, network card, PC interface cards for hardware communication, evaluation software	

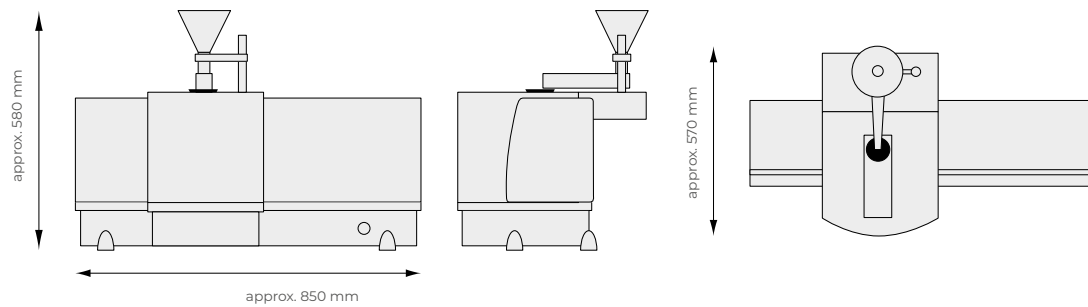

MICROTRAC

a **VERDER** company

Microtrac Inc.
3230 N. Susquehanna Trail
York, PA 17406 · USA

Phone: +1 888 643 5880
marketing@microtrac.com

Microtrac Retsch GmbH
Retsch-Allee 1-5
42781 Haan · Germany

Phone: +49 2104 2333 300
info@microtrac.com

www.microtrac.com

MicrotracBEL Corp.
8-2-52 Nanko Higashi, Suminoe-ku
Osaka 559-0031 · Japan

Phone: +81 6 6655 0360
info@microtrac-bel.com

Microtrac Formulaction SAS
5 rue Paule Raymondis
31200 Toulouse · France

Phone: +33 (0)5 62 89 29 29
contact.fr@mtf.verder.com

VERDER

 **ENABLING
PROGRESS**

Verder is composed of leading laboratory equipment companies active in sample preparation and analysis for quality control as well as research & development purposes.

As trusted solution partner, Verder Scientific enables thousands of companies to ensure economic, technological and environmental progress by mastering their scientific applications. Together, we make the world a healthier, safer and more sustainable place.

