



Faster, Smarter, More Efficient Moisture Analysis

Moisture affects everything we use on a daily basis therefore in many cases it is important to be able to accurately determine the moisture content of samples. Equipped to handle routine and sophisticated measurements, our flagship MB120 moisture analyzer makes the whole process faster, easier, and more efficient. The MB120 allows you to analyze more samples, access saved data, and spend less time prepping and more time putting your results to work.

Standard Features:

- Get started quickly with SmartGuide™. This revolutionary feature automatically analyzes a sample and creates a method, thereby removing the guesswork from the initial setup.
- The MB120 has the capability to produce fast and accurate results due to features such as a halogen heating system, customizable shut-off criteria and four built-in drying profiles.
- The MB120's allows storage of up to 100 methods and 1,000 measurement results. Stored results can be exported and methods can be shared across multiple devices.

MB120 *Moisture Analyzer*

Simple and Powerful Moisture Analysis



- **SmartGuide™**

SmartGuide™ automatically analyzes a sample and creates a method, simplifying the method creation process and removes the guesswork from the initial setup.

- **Fast and Efficient Halogen Heating Technology**

Halogen heating dries samples efficiently and in a fraction of the time versus a traditional loss on drying measurement with an oven. The MB120 has a full operating temperature range of 40–230 °C, settable in 1-degree increments.

- **Uniform Drying for Precise, Repeatable Results**

The reflective sample chamber ensures uniform heating of each sample to yield reliable results of 0.01 % readability.

- **Four Drying Profiles**

Customize heating of specific samples with various drying programs; Standard, Fast, Ramp, and Step.

Fast: Quickest possible time to temperature

Standard: Minimal overshoot while achieving temperatures quickly

Ramp: Controlled ramping to temperatures

Step: Set three temperatures at three time intervals

- **Flexible and Configurable Shut-Off Criteria**

Customize your own test endpoint criteria to automatically end the test once moisture loss is no longer detected. Choose one of the built-in standard criterion or define your own.

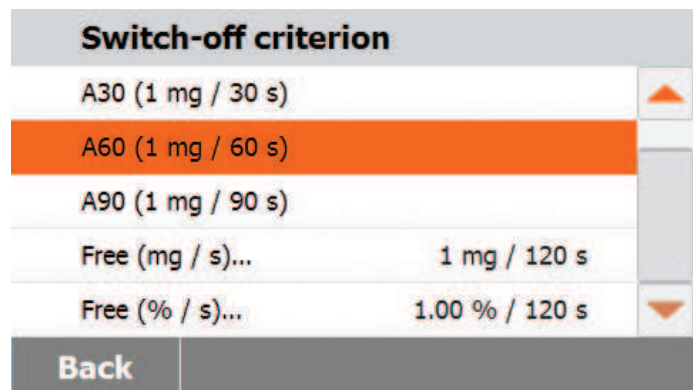
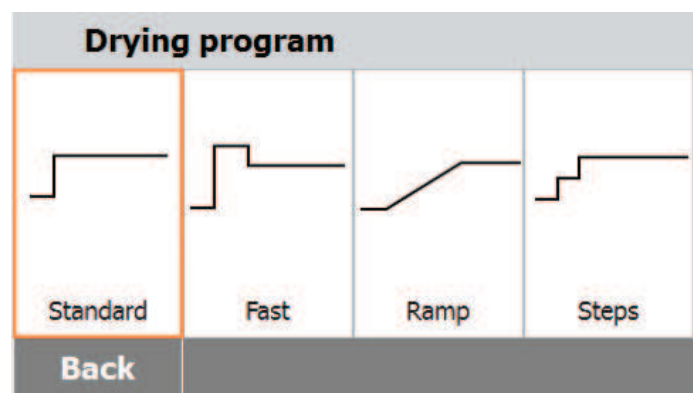
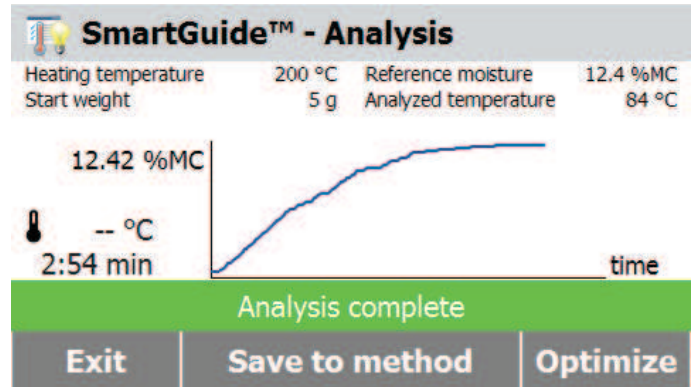

Default

23.08.2019 - 17:13	3.08 %MC
23.08.2019 - 17:02	3.13 %MC

Back Delete Export Statistics

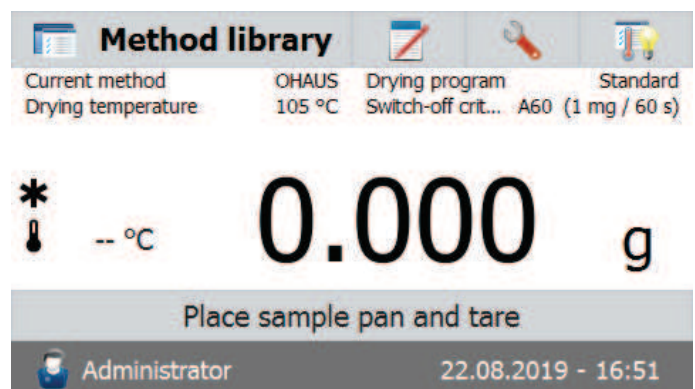

MB120 Moisture Analyzer



Advanced Functionality

- **Internal Method Library**
Store methods for up to 100 different samples - methods can be easily recalled and transferred to other units for quick setup.
- **Internal Result Storage**
The MB120 will store 1000 results which can be printed or exported via USB memory stick as a group or individually for further analysis.
- **User Management**
With User Management, MB120 provides operational control and aids compliance by restricting access so that unauthorized users may use the device but not change settings.
- **RS232 and USB Ports**
Quick connections to a printer, PC or flash drive.

Easy to Use and Maintain

- **Graphic Display with Touchscreen**
Navigate the device easily with an intuitive user interface on a bright, color, and easy-to-read graphic display
- **Icon-Driven Menu Navigation**
Easy to follow — no training required.
- **4 Mechanical Keys for Fast One-Step Operation**
Tare, Start/Stop, Print, On/Off
- **Easy Tool-Free Cleaning**
Stainless steel surfaces are resistant to corrosion and wipe down quickly. Heating chamber components can be easily removed for easy cleaning - no tools required.

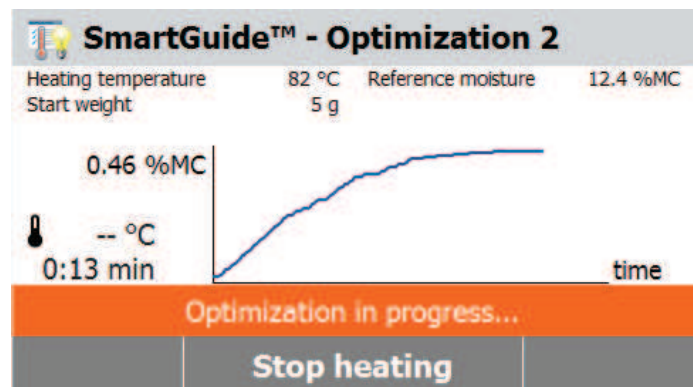
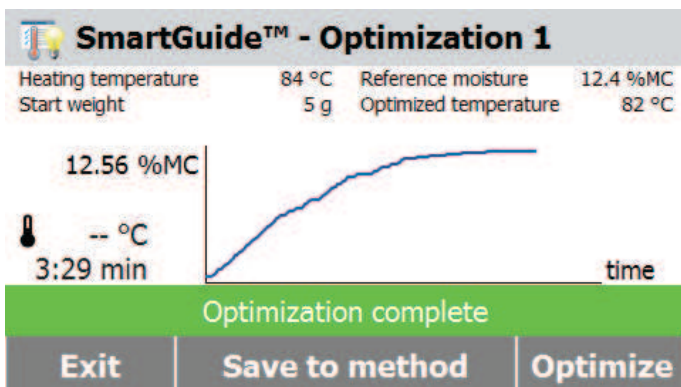

MB120 Moisture Analyzer

Model	MB120
Capacity	120 g
Readability	0.01 % / 0.001 g
Repeatability (Std Dev) (g)	0.05 % (3 g sample) 0.015 % (10 g sample)
Moisture Range	0.01 % to 100 % (0.01 % to 1000 % for regain mode)
Output	RS232, USB host, USB device
Heating Element	Halogen
Temperature Range	40 – 230 °C (1 °C Increments)
Power	120 or 240 VAC 50/60 Hz
Operating Temperature Range	10 °C – 40 °C
Display Type	109 mm, QVGA, TFT touch screen
Display Results	%moisture, %solids, %regain, time, temperature, weight, method name, drying curve and statistics
Pan Size	∅ 90 mm
Dimensions (W × H × D)	211 × 180 × 355 mm
Net Weight	5.23 kg
Shipping Weight	8.35 kg

Compliance

- **Product Safety:** IEC/EN 61010-1; IEC/EN 61010-2-010; CAN/CSA C22.2 61010-1; CAN/CSA C22.2 61010-2-010; UL 61010-1; UL 61010-2-010
- **Electromagnetic Compatibility:** IEC/EN 61326-1 Class B, Basic environments; FCC Part 15 Class A; Canada ICES-003 Class A
- **Compliance Marks:** CSA, CE, RCM, WEEE

Additional Features

ABS top housing, stainless steel pan support, stainless steel metal pan handler, in-use cover, Seven shut-off criteria (manual shut-off with pre-set time, timed, autofree %/s, autofree mg/s, A30, A60 and A90), Four heating profiles (standard, fast, ramp and step), user guide, 13 operational languages (display only, no key in)

Accessories

Pan Holder	30246947
In-Use Cover	30284478
Scoop	30284477
Temperature Calibration Kit	11113857
Anti-Theft Device	80850043
Aluminum pan packed with 50 pcs.	30585411
Glass Fiber Pads (200)	80850087
Cage, Sample	80252477
Reusable Pan (3), 7 mm High	80252478
Reusable Pan (3), 14 mm High	80252479
SF40A Impact Printer	30045641
Interface Kit, RS232-USB	30304101
Interface Kit, RS232-Ethernet	30304102

Outline Dimensions

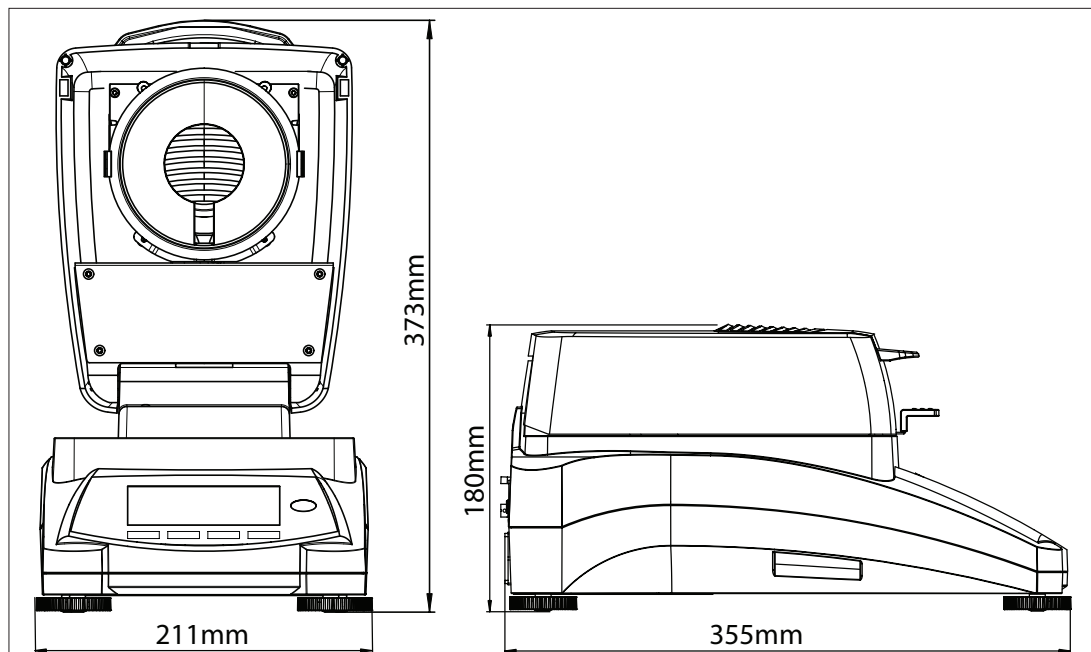

OHAUS Asia/Pacific Headquarters

7F, Block 33, 680 Guiping Road
Shanghai 200233
China

e-mail: APmarketing@ohaus.com
Tel: +86 21 64855408

www.ohaus.com

The management system governing the manufacture of this product is ISO 9001:2015 certified.

SAP Literature # 30385525

80776026_C 20200804 © Copyright OHAUS Corporation

