

# multisub

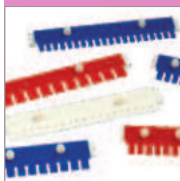

a **combination** of economy of gel and buffer volume, with gel size **and** sample number versatility



# multiSUB

## Horizontal Gel Systems

The multiSUB™ series of Horizontal Gel Units offers the most versatile solution for DNA and RNA agarose gel electrophoresis currently available.

- Injection Moulded Construction  
- durable, leak-proof environment for complete safety and long life
- Cassette Type Electrodes  
- inexpensive, easy to replace
- Electrodes made of 99.99% corrosion resistant, pure platinum
- Electrical Safety - lid can be attached in a single orientation. On removal, power is disconnected from buffer chamber
- Multiple Gel Trays - eliminate the need for additional gel tanks
- Unique gel cooling system
- Easy Click Lid Removal

All five units offer an unsurpassed combination of economy of gel and buffer volume, with gel size and sample number versatility.

Gel size and sample number requirements can be exactly matched in each unit, with the option of additional gel tray sizes. This eliminates the need for multiple gel tanks for changes in gel size or application.

All units feature removable UV transparent trays. For optimum value and versatility, systems are available with one, two or three tray options (dependent on model). Easy to use, leak proof 'plug and go' gel casting dams are included as standard to allow gels to be rapidly cast whilst the multiSUB unit is in use for gel running. With no indentations or casting gate grooves in the tray to interfere with sample progression, traditional tape casting can be used, should this be preferred.

Although lid connectors are compatible with most major power supplies, adapters are available to provide complete compatibility.

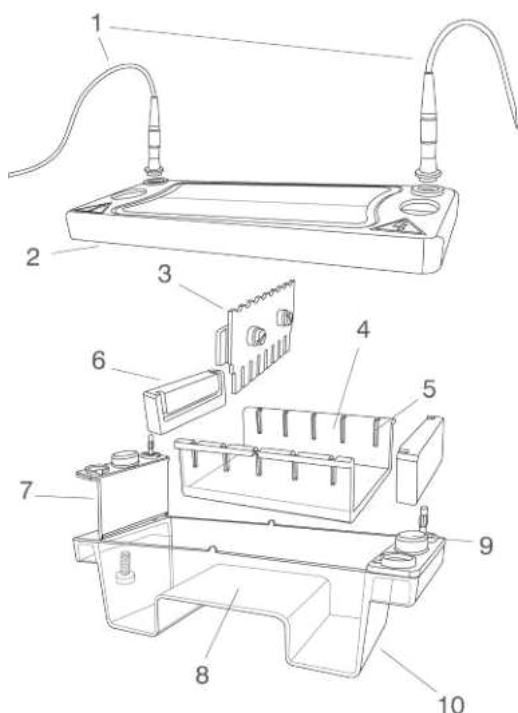

### Components of multiSUB gel chambers

- 1 Power Cables
- 2 Safety Lid & Viewing Pane
- 3 Height-adjustable comb
- 4 UV transparent gel tray
- 5 Comb slots
- 6 'Plug-and-Go' casting dams
- 7 Colour-coded electrodes with power plug connectors
- 8 Gel Platform
- 9 Safety lid thumb locators
- 10 Moulded tank

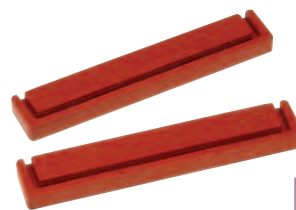

"plug and go"  
gel casting



Locate  
Edge #1 in  
Dam slot

Locate  
Edge #2 in  
Dam slot

Finished,  
simple.  
Now pour  
gel

# gel trays



Gel trays are UV transparent and free of indentations or casting gate channels which can interfere with sample progression

Cassette Type Electrodes - easy to replace

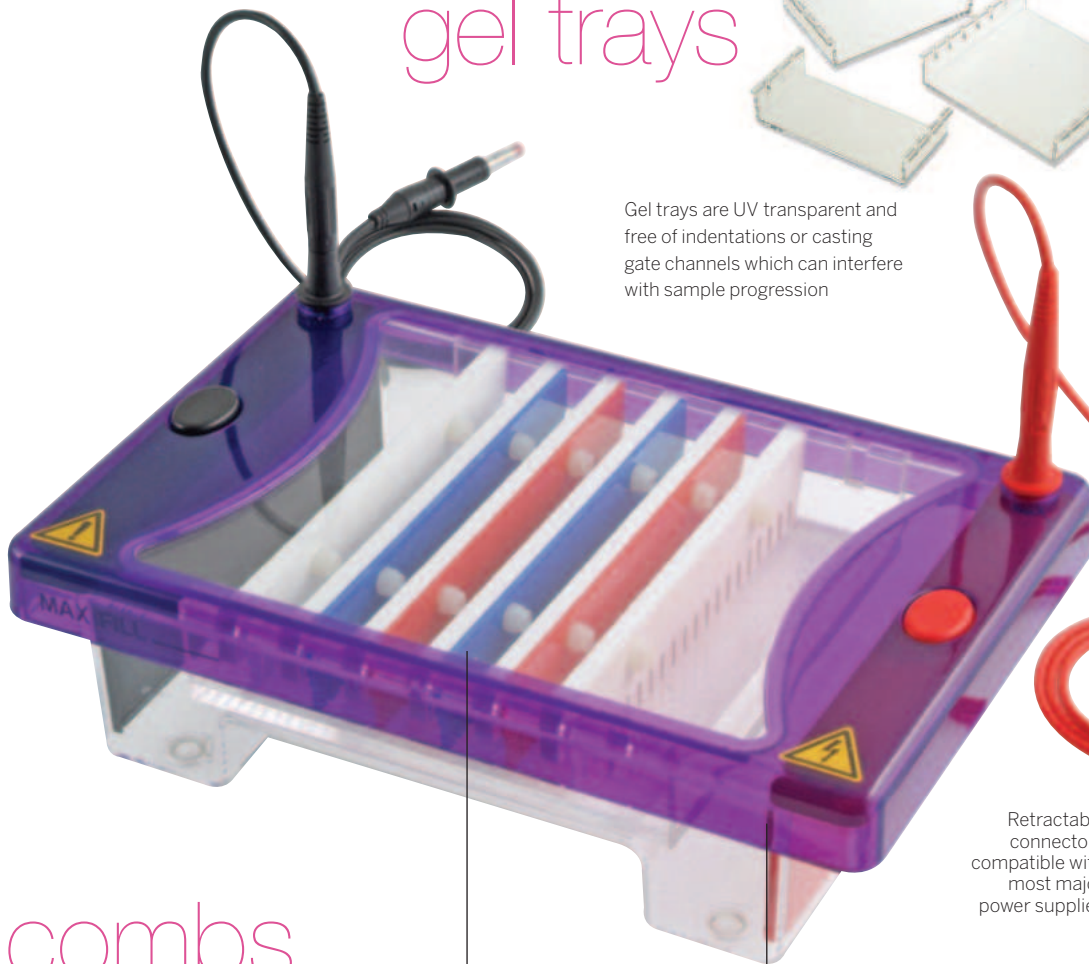
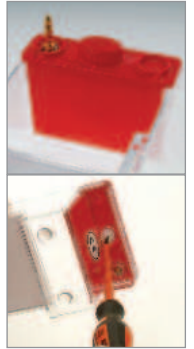

Retractable connectors compatible with most major power supplies



Corrosion resistant, 99.99% pure platinum electrodes and gold plated terminals - easily replaced, ensuring minimum repair times

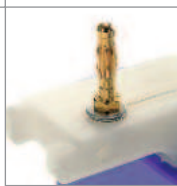

# combs

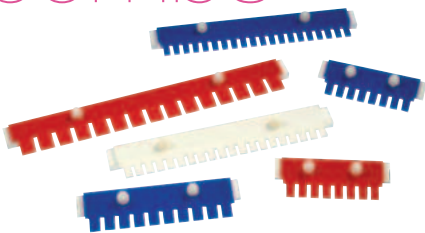

- four thicknesses, colour coded
  - black:** 0.75mm for ultra resolved bands
  - white:** 1mm supplied as standard
  - red:** 1.5mm for maximising sample volume
  - blue:** 2mm for maximising sample volume

- options for Sample Prep
- options for Multi-Channel Pipette Compatible

The number of samples can be maximised using high tooth number combs

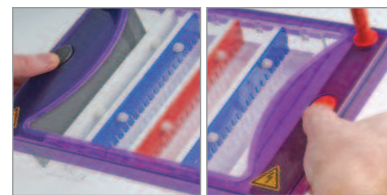

Easy Click Lid Removal

Casting dams allow gels to be rapidly cast externally while the multiSUB™ unit is in use for gel running

# unique clearsight



USB powered extraction fan

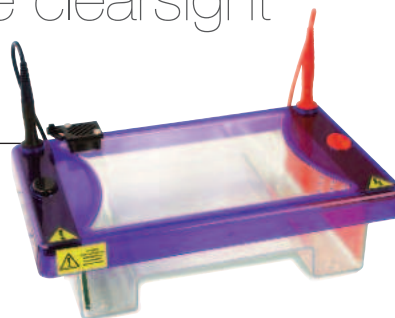

ClearSight lids solve the condensation build-up problem and so provide a perfectly clear view of the gel and the dye lane progression during the run. This is achieved using a USB powered extraction fan within the lid. ClearSight lids are available as components of complete systems or as upgrades.



UK designed and manufactured



# multiSUB selection guide

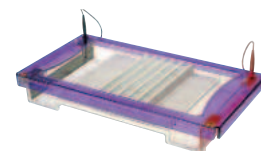
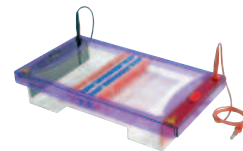
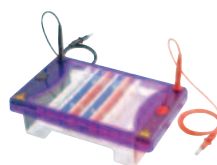
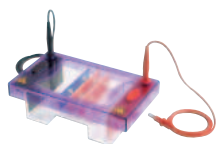
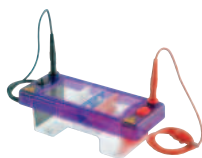

	MSMINI	MSMIDI	MSCHOICE	MSMAXI	MSSCREEN
	The preferred option for quick sample checks, particularly following restriction digestion during cloning. Its slim tray format makes the MSMINI a very economical choice for separation of up to 64 samples.	These units offer the same trays lengths, but in a wider format, to run more samples just as economically as in the MSMINI under similar running conditions.	Wide format system offers 2-3 times the sample capacity as the MSMINI and MSMIDI units. A comprehensive selection of combs provides full flexibility for preparatory and screening techniques. Suitable for cloning and mini-prep analysis.	Large-format system is versatile enough to be used for routine preparatory and high-throughput techniques. Combs with spacing compatible with fixed multichannel pipettes simplify loading from 96-well microplates and thermal cycler blocks. Suitable for RFLP analysis, Southern and northern blotting applications, plus DNA library and PCR fragment analyses.	Supplied with six 28-sample multichannel compatible combs, with well-spacing that favours direct loading. The content of at least one 96-well microplate or thermal cycler block may be screened in a single gel. Standard combs may be exchanged for 56-sample versions to double the sample capacity. A dedicated system for all high-throughput screening.
Unit Dimensions (w x l x h)	9 x 21 x 9cm	12.5 x 22 x 9cm	17.5 x 26.5 x 9cm	23 x 39.5 x 9cm	28 x 50 x 9cm
Active Gel Size (w x l) / Corresponding Gel Tray	7x7cm / MS7-UV7 7x10cm / MS7-UV10	10x7cm / MS10-UV7 10x10cm / MS10-UV10	15x7cm / MS15-UV7 15x10cm / MS15-UV10 15x15cm / MS15-UV15	20x10cm / MS20-UV10 20x15cm / MS20-UV15 20x20cm / MS20-UV20 20x25cm / MS20-UV25	26x16cm / MS26-UV16 26x24cm / MS26-UV24 26x32cm / MS26-UV32
Sample Capacity	1-32 (7x7cm) <sup>a</sup> 1-64 (7x10cm) <sup>b</sup>	1-50 (10x7cm) <sup>a</sup> 1-100 (10x10cm) <sup>b</sup>	1-70 (15x7cm) <sup>a</sup> 1-140 (15x10cm) <sup>b</sup> 1-210 (15x15cm) <sup>c</sup>	1-200 (20x10cm) <sup>b</sup> 1-350 (20x15cm) <sup>c</sup> 1-450 (20x20cm) <sup>d</sup> 1-550 (20x25cm) <sup>e</sup>	28-336 (26x16cm) <sup>c</sup> 28-504 (26x24cm) <sup>e</sup> 28-672 (26x32cm) <sup>f</sup>
Tank Buffer Volume	225ml	300ml	500ml	1200ml	1400ml
Buffer Recirculation	No	No	Recommended for high voltage applications or extended runs. Requires modified lid with 2 buffer recirculation ports. Available on request as per part numbers below: - MS15LID-BP	MS15STLID-BP	Yes – buffer recirculation ports included as standard
Plug-and-Go Casting Dams Supplied	Yes, 1 pair	Yes, 1 pair	Yes, 1 pair	Yes, 1 pair	No – supplied with dedicated MSSCREEN flexicaster
Flexicaster Options & Tray Capacity	MS7/10-FC: 1 tray MS15/20-FC: 2 trays* MS26-FC: 3 trays*	MS7/10-FC: 1 tray MS15/20-FC: 1 tray MS26-FC: 3 trays*	MS15/20-FC: 1 tray MS26-FC: 1 tray	MS15/20-FC: 1 tray MS26-FC: 1 tray	MS26-FC: 1 tray
Typical Running Conditions	80V, 45-60 minutes	90V, 45-60 minutes	90-150V, 60-90 minutes	100-150V, 60-90 minutes	100-150V, 90-120 minutes
Bromophenol Blue Migration	~4-5cm/h at 80V	~4-5cm/h at 90V	~4-7cm/h at 90-150V	~4-6.5cm/h at 100-150V	~4-6cm/h at 100-150V
Ordering Information	<b>MSMINI7</b> , 7 x 7cm UV Tray <b>MSMINI10</b> , 7 x 10cm UV Tray <b>MSMINIDUO</b> , 7 x 7cm and 7 x 10cm UV Tray 2 x 8 sample combs, loading guides and casting dams	<b>MSMIDI7</b> , 10 x 7cm UV Tray <b>MSMIDI10</b> , 10 x 10cm UV Tray <b>MSMIDIDUO</b> , 10 x 7cm and 10 x 10cm UV Tray 2 x 16 sample combs, loading guides and casting dams	<b>MSCHOICE7</b> , 15 x 7cm UV Tray <b>MSCHOICE10</b> , 15 x 10cm UV Tray <b>MSCHOICE15</b> , 15 x 15cm UV Tray <b>MSCHOICETR</b> , 15 x 7cm, 15 x 10cm and 15 x 15cm UV Tray 2 x 20 sample combs, loading guides and casting dams	<b>MSMAXI10</b> , 20 x 10cm UV Tray <b>MSMAXI15</b> , 20 x 15cm UV Tray <b>MSMAXI20</b> , 20 x 20cm UV Tray <b>MSMAXI25</b> , 20 x 25cm UV Tray <b>MSMAXIDUO</b> , 20 x 10 and 20 x 20cm UV Tray 2 x 20 sample combs, loading guides and casting dams	<b>MSSCRN16</b> , 26 x 16cm UV Tray <b>MSSCRN24</b> , 26 x 24cm UV Tray <b>MSSCRN32</b> , 26 x 32cm UV Tray <b>MSSCRNTRIO</b> , 26 x 16cm, 26 x 24cm and 26 x 32cm UV Trays 6 x 28 sample combs, loading guides and Flexicaster

<sup>a</sup> Assumes 1-2 combs per gel; <sup>b</sup> Assumes 1-4 combs per gel; <sup>c</sup> Assumes 1-6 combs per gel; <sup>d</sup> Assumes 1-9 combs per gel; <sup>e</sup> Assumes 1-11 combs per gel; <sup>f</sup> Assumes 1-12 combs per gel  
\* Assumes multiSUB™ trays are of the same length (e.g two MS7-UV7) and arranged side-by-side.

## CLEAVER SCIENTIFIC LTD

Unit 41, Somers Road Industrial Estate,  
Rugby, CV22 7DH  
United Kingdom

T\_ +44 (0)1788 565300  
E\_ INFO@CLEAVERSCIENTIFIC.COM  
W\_ WWW.CLEAVERSCIENTIFIC.COM