

CAPILLARY RHEOMETER

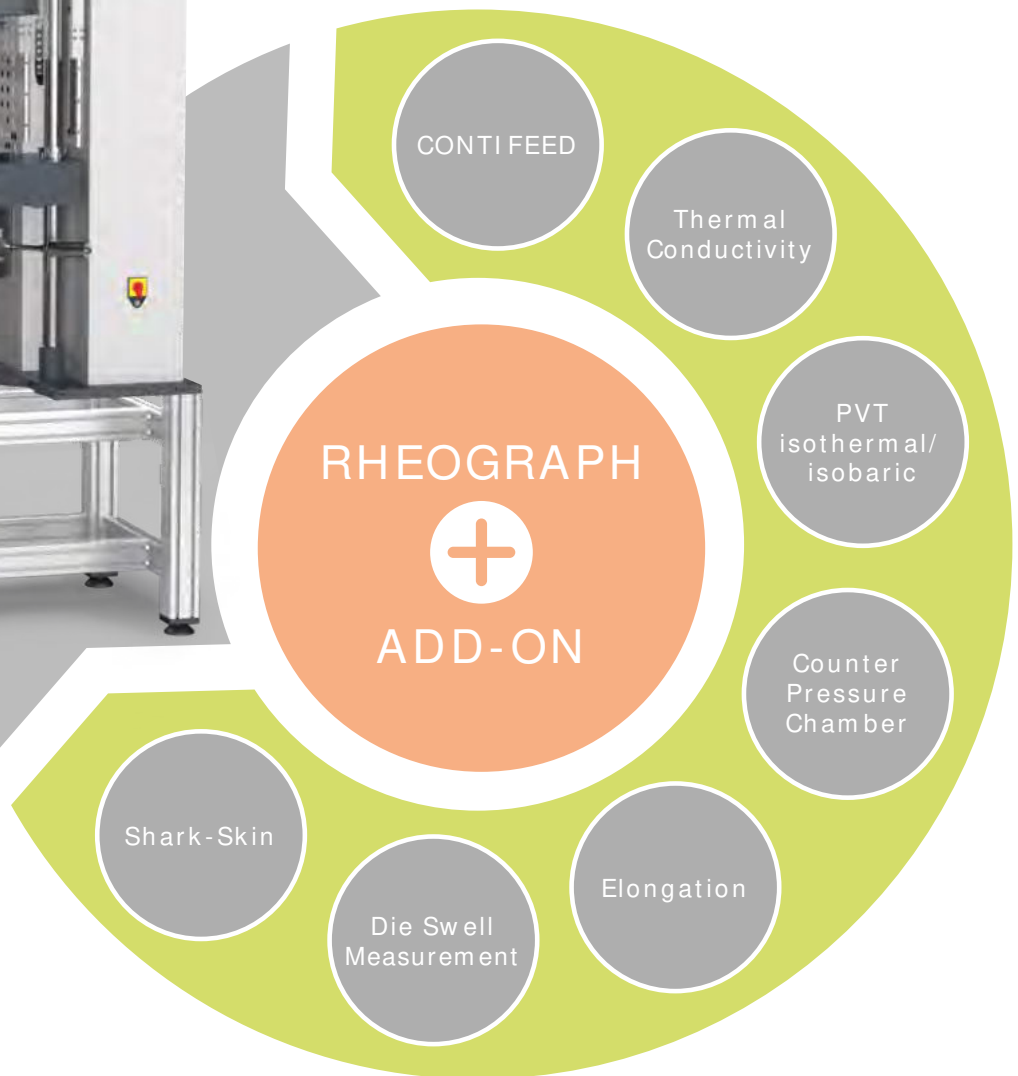

HIGH PRESSURE CAPILLARY RHEOMETER

One or multiple channels for detection of flow and viscosity

RHEOGRAPH 20, 25, 50, 75 and 120 have been redeveloped based on 40 years of experience by previous generations.

A higher level of automation and user friendliness, larger shear rate range, as well as an unforeseen variety of testing weights fulfill all customer desires.

The integrated colored touchscreen, the automatic pressure recognition, as well as signal processing of the pressure value (0,005 % resolution) are just some of the newest features.

With the script capable PC-software LabRheo, the machines suit perfectly the demands of users in research & development, quality control, as well as incoming goods inspection.

- The option of a single, dual or triple barrel system with a resolution of 9.5, 12, 15, 20, 25 or 30 mm, as well as flexible measurement is possible
- Speed between 0,00004 - 40 mm/s (1:1000000), RG20: 0,0001 - 40mm/s
- Dynamic test stamp acceleration: from 0 to 40 mm/s in 0.6 seconds
- Position tracking with high resolution encoder
- Temperature control range up to 400 °C (500 °C optional), display resolution 0.01 °C
- Automatic pressure transducer detection and identifying „Plug & Test“
- Adaptive signal resolution of 0.005 % from the pressure transducer range



FROM 0 TO 40 MM/S IN 0.6 SECONDS

ADVANCED THROUGH HIGHER ACCURACY

With the new generation of the RHEOGRAPH, the accuracy of the pressure transduction has increased 10 times, which shows that accuracy leads to the extension of the measurement area by one decade. One pressure transducer now works with a resolution of **0.1 bar or 30000 PSI > 1.5 PSI!**

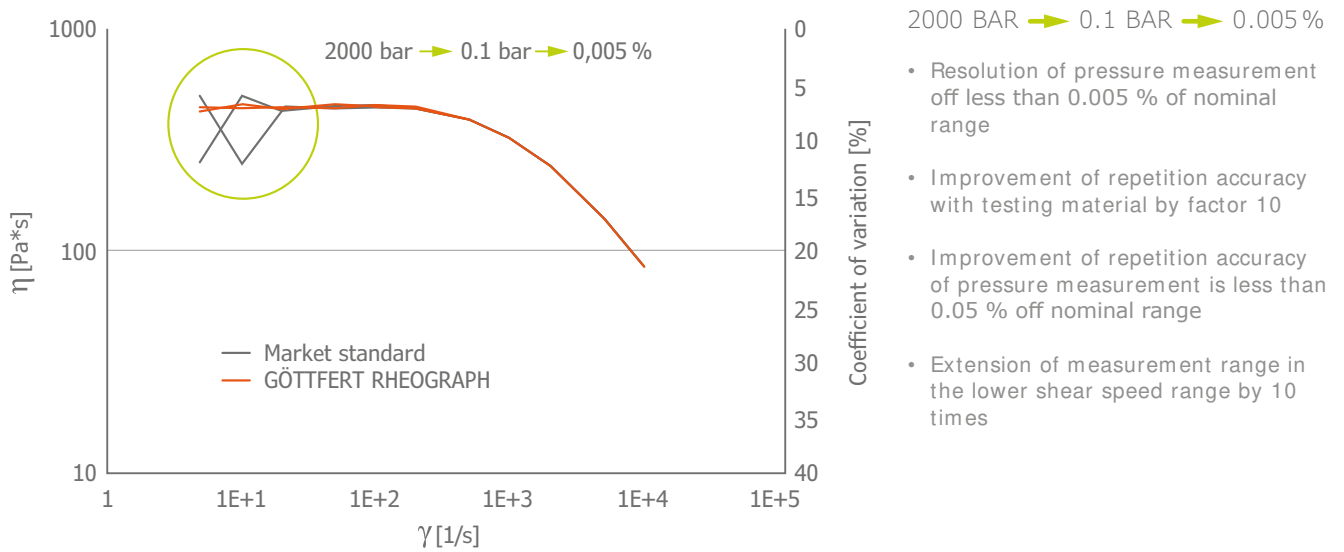

RHEOGRAPH 20

Perfect entry level model for viscosity measurements



HIGHLIGHTS

- Constant and high stamp force of 20 kN
- Test barrel diameter of 9.5 mm, maximum pressure of 2500 bar
- Dynamic speed range: 0.0001 - 30 mm/s (0.006 - 1800 mm/min)
- Path tracking with high resolution encoder (0.000053 mm)
- Modern cooling system, cooling rate of max. 30 K/min
- No liquid cooling necessary, but possible on an optional basis
- Integrated tempering cover
- PVT-Measurement either isothermal or isobaric
- Optimized test barrel, less heat supply necessary



RHEOGRAPH 20

The entry level model of the newly developed high pressure capillary rheometer made by GÖTTFERT is a rheometer with a test force of 20 kN. Besides measuring viscosity, the RG20 is capable of accessing the GÖTTFERT Add-on platform for the extended material characterization. This is a value added factor in the characterization of material specific behavior. The well established single or multiple barrel models complete the platform of capillary rheometers alongside usage specific capillaries and optional special editions.

The essential improvement of the GÖTTFERT capillary rheometer has been achieved through the higher accuracy of pressure measurements. Reproduction and higher precision have been improved by factor 10. Therefore, the measurement range in the lower shear rate range has been extended.

GÖTTFERT clearly distinguished itself from the market through the improvements in the lower shear rate area.

According to the standards:

- DIN 54811
- ASTM D3835
- ISO 17744 (PVT)
- ASTM D5930 (TC)
- ASTM D5099
- ISO 11443

ADD-ON

- PVT (Pressure, Volume, Temperature)
- Elongation (HAUL-OFF, RHEOTENS)
- Contifeed
- Shark-Skin
- Thermal Conductivity
- Counter-Pressure-Chamber
- Die Swell Measurement

RHEOGRAPH 25/50/75/120

Newly developed and user friendly high pressure capillary rheometer with higher shear rate range and higher measuring force



HIGHLIGHTS

- 25 - 120 kN measuring force
- The option of a single, dual or triple barrel system with a resolution of 9.5, 12, 15, 20, 25 or 30 mm, as well as flexible measurement is possible
- Speed between 0,00004 - 40 mm/s (1:1000000), RG20: 0,0001 - 40mm/s
- High dynamic acceleration of the test stamp from 0 to 40 mm/s in 0.6 seconds
- Path tracking with high resolution encoder
- Temperature control range up to 400°C (500°C optional)
- Adaptive signal resolution of 0.005 % from the pressure transducer range

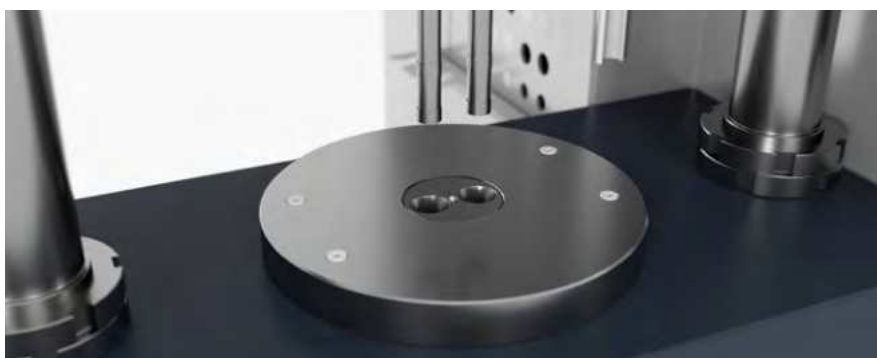

RHEOGRAPH SERIES

The newly developed GÖTTFERT series of high pressure capillary rheometers is available with different testing force of RG 25, 50, 75 or 120 kN. Therefore, the RG120 is capable of measuring higher testing force and higher shear rate. The diverse program of Add-ons is an unforeseen platform on the market of capillary rheometry for the extended material characterization. Besides determining of viscosity, modular Add-ons add essential value to the characterization of material specific behavior. The established single or multiple barrel options complete the platform of capillary rheometry alongside multiple user specific capillaries as well as optional special editions.

The essential improvement of the GÖTTFERT capillary rheometer has been achieved through the higher accuracy of pressure measurements. Reproduction and higher precision have been improved by factor 10. Therefore, the measurement range in the lower shear rate range has been extended.

GÖTTFERT clearly distinguished itself from the market through the improvements in the lower shear rate area.

According the standards:

- DIN 54811
- ASTM D3835
- ISO 17744 (PVT)
- ASTM D5930 (TC)
- ASTM D5099
- ISO 11443

ADD-ON

- PVT (Pressure, Volume, Temperature)
- Elongation (HAUL-OFF, RHEOTENS)
- Contifeed
- Shark-Skin
- Thermal Conductivity
- Counter-Pressure-Chamber
- Die Swell Measurement

RHEOGRAPH ADD-ON

Modular platform for the extended characterization of polymers

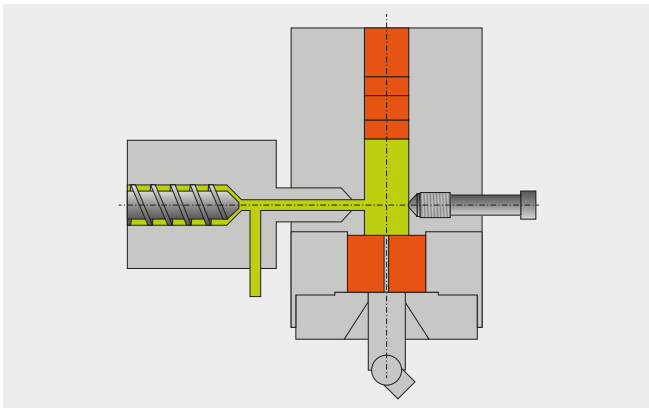

CONTIFEED

- Bubble free filling of the test channel
- Automatic loading of bulky samples possible
- Time saving up to 50 % during testing process through more effective heating
- Shorter heating period for shorter material dwell time through influence of temperature
- Recognition of process relevant rheological data for injection molding
- By pre-plastification powder materials like PVC dry batches can be measured as well

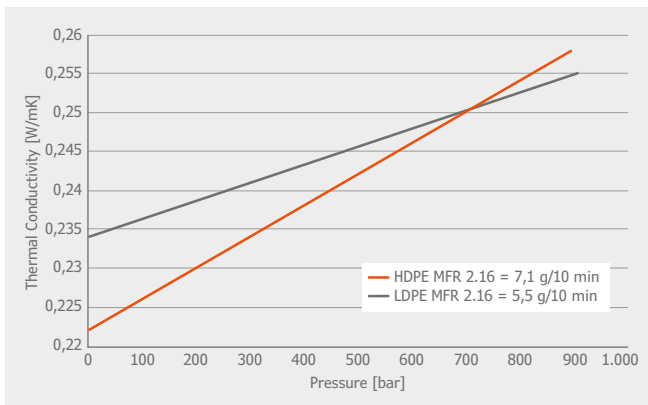

THERMAL CONDUCTIVITY

- Determination of heat conductivity
- Measurement Range: Temperature up to 450 °C, Pressure up to 1000 bar
- Developed according to ASTM D5930
- Test sensor with integrated heat device and ability to track temperature
- Optimization of cycle time during injection molding
- No mechanical retooling necessary
- Simulation of process
- Available with automatic process steering

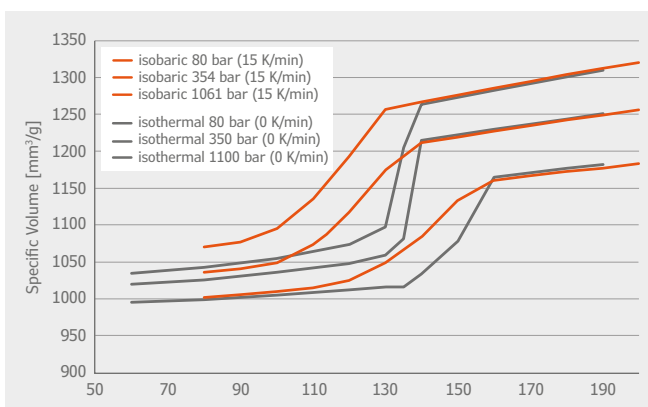

PVT (ISOBARIC & ISOTHERMAL)

- Measuring process according to ISO 17744
- Determination of data about pressure, volume and temperature
- Measuring setting isobar and isotherm
- Variable testing body volume
- Easy handling through quick release fastener
- Illustration of PVT Diagram
- Optimization of Flow- and Shrink process
- Available with automatic process steering

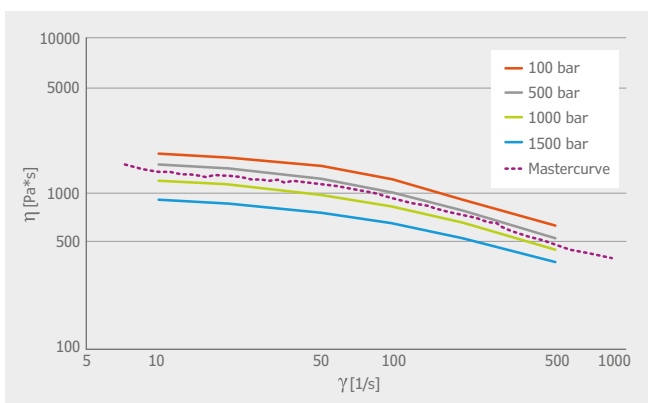

COUNTER PRESSURE CHAMBER*

- Determination of pressure coefficient
- Determination of critical wall shear stress wall slides
- Max pressure (Pm) 1200 bar
- Temperature range up to 400 °C
- Optimization of flow process in processing machines (Injection molding, Extrusion tools with long flow paths, Melt pumps)

* Further information on page 12!



ELONGATION TESTING

RHEOTENS:

- Infinitely variable speed
- Free selection between linear and exponential acceleration
- Setting, steering of measuring process and test analysis with Windows Program RHEOTENS 97
- Different pull-off wheels – to be specified depending on usage
- Tandem pull-off wheels
- Already existing RHEOTENS machines can be upgraded with new electronic box as well as "RHEOTENS 97".



HAUL-OFF:

- Indefinitely variable speed of 0 - 600 m/min, optional from 0 - 2000 m/min
- Optional selection between linear or exponential acceleration
- Anti-adhesion surface of pull-off wheel
- Measurement range up to 1 N, Resolution 0.05 mN
- Software for setting, steering of measurement and analysis

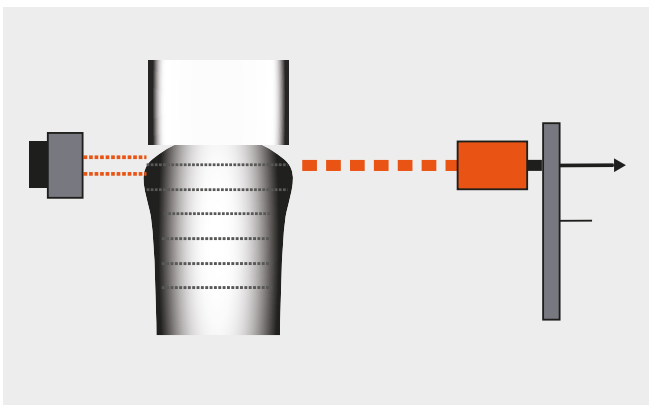

DIE SWELL MEASUREMENT

- Determination of dynamic and static die swell
- Analysis of threshold profile (BASELL Method)
- Swivel with infinitely variable height setting
- Laser measuring head in 0.1 μm or 7 μm edition
- Optional with automatic melt cutting device
- Application: Simulation of Material-Threshold behavior during injection molding

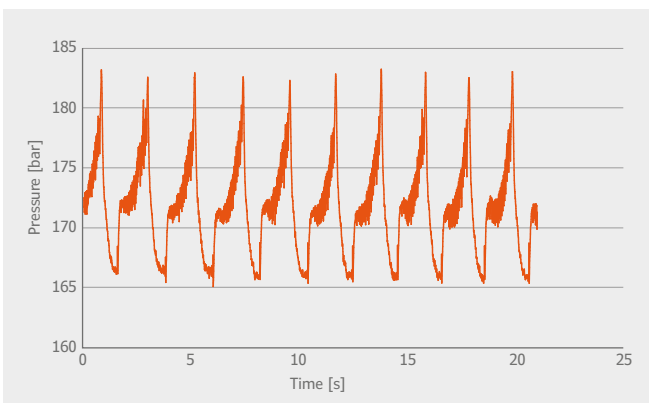

FLOW INSTABILITIES

(SHARK-SKIN, SLIP STICK,...)

- Measuring cell for tracking of Shark-Skin effect
- Consisting of slit die, three high frequency sensors (rate up to 20 kHz), as well as software package
- Determination of frequency spectrum, as well as statistical analysis of pressure signal
- Optimization of extrusion-, film and coating process

PVT500

Testing device for exercising isobaric and isothermal PVT measurements with inspection of material specific behavior



HIGHLIGHTS

- Constant and high stamp force of 20 kN
- Test barrel diameter of 9.5 mm, maximum pressure of 2500 bar
- Dynamic speed range: 0.0001 - 30 mm/s (0.006 - 2400 mm/min)
- Path tracking with high resolution encoder (0.000053 mm)
- Modern cooling system, cooling rate of max. 30 K/min
- No liquid cooling necessary, but possible on an optional basis
- Integrated tempering cover
- PVT-Measurement either isothermal or isobaric
- Optimized test barrel, less heat supply necessary
- Determination of D3-Coefficient

PVT500

PVT stands for Pressure Volume and Temperature. Isothermal PVT measurements test material specific behavior at constant temperature and variable pressure and force. The isobaric PVT measurement however is exercised at constant pressure and variable temperatures. The collected data from measuring with the PVT500 are especially relevant for the simulation of injection molding processes. The PVT-measuring delivers an equally accurate description of the cooling process as taken place in the extrusion. The PVT500 comes with the established software LabRheo, in which individual testing parameters can be selected. Additionally, there is the option to have real time monitoring of measurements. After defining parameters with the LabRheo script generator, the automatic measurement starts. Besides measurements according to ISO 22007 and ASTM D5930, the PVT500 is also capable of fulfilling measurements according to ISO 17744. Since its efficient air conditioning, the testing device does not need an additional thermostat, which saves significant amount of space.

According to the standards:

- ISO 17744 (PVT)
- ASTM D5930 (TC)
- ISO 22007

PVT ISOBARIC

Measurements according to ISO 1744 are standard for instruments with a test piston. Isobaric measurements are being completed under constant pressure and progressively changing temperature. Therefore, the material specific volume can be determined as a function of temperature and pressure. A central part of the PVT-measurement is the cooling behavior, which is relevant for injection molding processes. GÖTTFERT offers the opportunity to measure isobaric and isothermal PVT-measurements, either with the capillary rheometer Add-on PVT or the stand alone instrument PVT500.

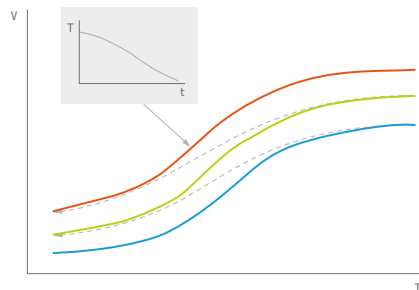

ADD-ON

Besides isobaric and isothermal PVT measurements, there is also the option to determine the thermal conductivity with the PVT500.

PVT ISOTHERMAL

During the isothermal PVT-measurement, the material is being filled in at melting temperature and cools up to room temperature. Pressure is then progressively increased, before the next temperature level is being started. This measuring cycle of different pressures, is being applied to earlier defined temperature levels. GÖTTFERT offers the opportunity of isothermal and isobaric PVT-measurements with the capillary rheometer Add-on PVT or the stand-alone PVT500.

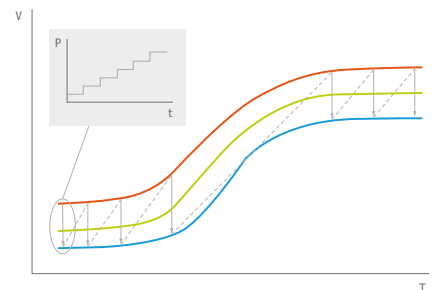

OPTIONS

- Additional temperature control with external thermostat

COUNTER PRESSURE

Different and multiple test modes in one instrument



HIGHLIGHTS

- Constant high piston force over the entire speed range
- Speed range: 0.0004 mm/s to 40 mm/s
- (0.0024 mm/min - 2400 mm/minute), corresponding to a ratio of 1: 1,000,00
- High dynamic die acceleration: 0 - 40 mm/s in 0.6 seconds
- Position Detection: High Resolution Encoder (0.0000016 mm)
- Automatic pressure sensor recognition: Plug & Test

COUNTER PRESSURE

This modified capillary rheometer consists of two connected capillary rheometers and can be used in different test modes. Therefore, both rheometers can be used independently.

The counter pressure viscosimeter is a rheological instrument, that is used for the determination of the viscosity of plastics and other flow able materials in dependence to counter pressure. It consists of two capillary rheometers, which are simultaneously connected through a connection barrel and are therefore both able to influence the test sample. With this modified instrument, it is possible to determine the flow curve of materials in dependency to counter pressure.

Barrel 1 (B1) is being used for viscosity measurements and barrel 2 (B2) is being used for the regulation of counter pressure.

According to the standards:

- DIN 54811
- ASTM D3835
- ISO 17744 (PVT)
- ASTM D5930 (TC)
- ASTM D5099
- ISO 11443

ACCURACY

The signal of pressure transducer RG20, RG25, RG50, RG74 and RG120 can be shown with a resolution 0.005 % off the par range, which means 0.1 bar with a 2000 bar sensor. All of GÖTTFERT's pressure sensors are being calibrated with our software in order to guarantee highest quality.

FUNCTION

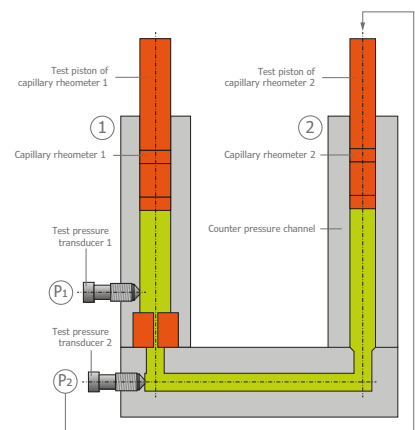

The RG Counter Pressure offers the opportunity to automatically measure different viscosity functions under counter pressure. Capillary rheometer 2 regulates counter pressure. After a flow curve is determined, the material is being pushed from capillary rheometer 2 into capillary rheometer 1. Now, a flow curve can be measured under different counter pressure. The illustration shows a schematic example of two connected capillary rheometers.

RHEOGRAPH 25E

Determination of flow behavior and viscosity of thermoplastic materials, as well as the production of pharmaceutical implants



HIGHLIGHTS

- Complete stainless steel edition, for usage in clean room, category A
- Piston speed of 0.00004 until 40 mm/s over entire force measuring range 25 kN
- Test barrel diameter of 20 mm
- Temperature regulation of +30 °C until +250 °C
- Measuring mode „constant speed“ or „constant force“
- Determination of test piston speed, apparent and true shear stress
- Selecting parameters, steering and measurement with software LabRheo, Analysis with software WinRheo 2
- SCRIPT-Steering for three defined measuring- and production processes

RHEOGRAPH 25E

The Rheograph 25E is an innovative high pressure capillary rheometer for the determination of flow behavior and viscosity of thermoplastic plastics and rubber, as well as for the production of pharmaceutical implants. Contrary to the usual snail extrusion, the RHEOGRAPH 25E uses the RAM-Extrusion with mixed mass (ingredient and pharmaceutical substance) filled into a cylindric channel. The mixture is now compromised, heated and melted. At constant stamp speed, the melted material is being extruded. This method guarantees a homogeneous and bubble free string.

OPTIONS

- Die Swell Measurement

MAINTENANCE AND CALIBRATION

material testing equipment stands for a long lifetime combined with a low failure rate

In order to guarantee reproducible and reliable test results, periodic maintenance is necessary. A world wide operating team of our service engineers, guarantees sustainable, reliable and accurate rheological test results.

Only frequent maintenance guarantees the reliability of our instruments. We are offering service contracts, which are adjusted to your individual needs. Our professionally trained service team, as well as our quality management system (according to the international standard DIN EN ISO 9001), we are guaranteeing a fast and reliable service.

Our service engineers have the opportunity to exercise the following maintenance actions in accordance to ISO/IEC 17025:

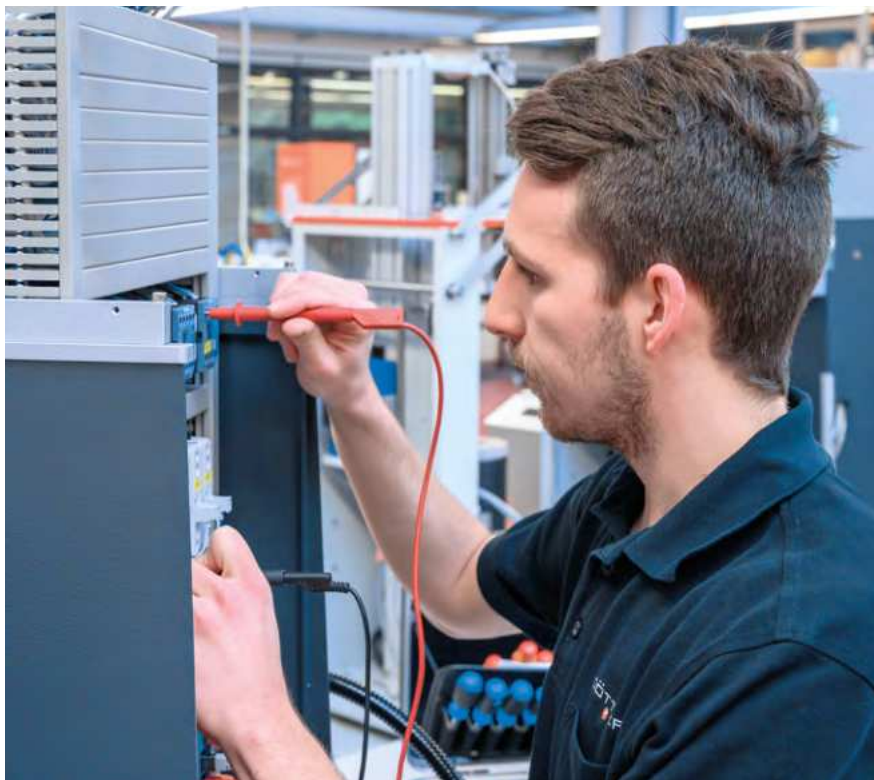

SUITABLE SERVICE FOR DIFFERENT REQUIREMENTS

SERVICE BASIC*

Maintenance and calibration of the instrument with traceable measuring devices.

After successful completion a maintenance check list (inspection protocol) will be provided.

* SERVICE BASIC is no longer provided for manually operated melt flow indexers of the current model series.

SERVICE BASIC PLUS

Maintenance with factory calibration protocol: Maintenance and calibration of the instrument with traceable measuring devices, including statistical measurement uncertainty, which has been determined by an evaluation of the statistical measurands on several different instruments.

After successful completion a factory calibration protocol (inspection protocol) will be provided.

SERVICE ISO 17025

Maintenance and calibration of the instrument with traceable measuring devices, including an indication of the lowest measurement uncertainty, which has been determined directly at the test device on site.

After successful completion a verification report will be provided in accordance with the requirements of ISO 17025.

EXTENDED PROTECTION

for melt flow indexer and high pressure capillary rheometers

All GÖTTFERT testing instruments are under a legal warranty of 1 year. The »Extended Protection« additionally offers warranty of another 24 months for our manual melt flow indexer and high pressure capillary rheometers as long as a maintenance contract is being signed (run time of 36 months after acquisition and up to 12 months after). This includes maintenance visits once or twice a year in order to guarantee the reliability of the machine.

We would love to create a perfectly suited offer for your needs, which could include additional advantages of **SERVICE BASIC PLUS** or **SERVICE ISO 17025**. This includes discounted spare parts or priority treatment for requests. Therefore budget calculations and forecasts are made easier.

STANDARD

EXTENDED

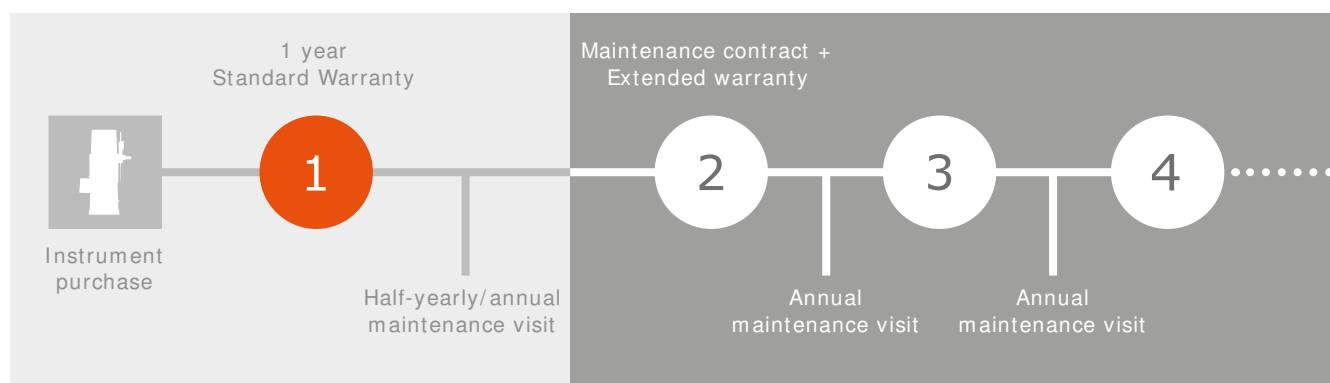

ADVANTAGES

- Cleaning, function check, exchange of wear parts* and calibration with certified standards according to the maintenance protocol **SERVICE BASIC** as well as calibration with factory calibration protocol **SERVICE BASIC PLUS** or **SERVICE ISO 17025**.
- Spare parts and travel costs are included in **SERVICE BASIC** (except consumables and wear materials* , as well as damages caused by the user or transport costs)
- The »Extended Protection« is available from the time of purchase and up to 12 months thereafter
- Upon request, individual offers are also prepared
- Software updates within the software version (subgroup) included
- Software updates according to individual offer

* Wear parts are test channels, test pistons, capillaries, test piston holder, touchscreen (control panel), gas pressure feather of protection cover, as well as cleaning tools and cleaning materials

SOFTWARE

LabRheo – Network compilable software system for finding parameters, measurements and analysis

FUNCTIONS

The user friendliness, the wide spectrum of application opportunities and the saving of testing data were a central point and priority in the redevelopment of this program.

Terminal-independent functions:

- Free illustration of raw values- and analysis graphic
- Continuous display of instrument status
- Automatic reading of testing instrument information
- Self explanatory dialogs and information fields, Online assistance
- Open platform for application specific fields, filter for measurements
- Selective access right for optimized security
- Script steered measuring process

ANALYSIS WITH WINRHEO II

- Calculations for round hole capillaries and slit capillaries
- Corrections like Rabinowitsch-Weissenberg, Bagley (linear/not linear), Mooney, Hagenbach, Gleissle
- Approximation of flow curves according to the following models: Ostwald-De Waele (power set), Carreau-Winter, Yasuda, Sabia, Mündstedt and Cross
- Elastic viscosity after Cogswell
- Extensive analysis like Non-Newton-Index (NNI factor), thermo stability, relaxation, wall slipping and ramps
- Normal voltage
- PVT Diagram and Tait Adjustment
- Temperature Shift: Creation of master curves out of flow curves at different temperatures, Determination of model coefficient for master curve, approximation of master curve after Carreau-Winter and Cross, Calculation of shift factors after WLF and Arrhenius



PERFORMANCE DATA



Model	RG20	RG25	RG50	RG75	RG120
Force range	20 kN	25 kN	50 kN	75 kN	120 kN
Test barrel geometry* : 1-Barrel					
9.55 mm / 12 mm / 15 mm / 20 mm	•	•	•	•	•
9.55 mm / 12 mm / 15 mm / 20 mm / 25 mm	-	•	•	•	•
9.55 mm / 12 mm / 15 mm / 20 mm / 25 mm / 30 mm	-	-	-	•	•
Test barrel geometry* : 2-Barrel					
2x 12 mm / 2x 15 mm / 1x 12 mm + 1x 15 mm	•	•	•	•	•
2x 12 mm / 2x 15 mm / 1x 12 mm + 1x 15 mm / 2x 20 mm	•	-	-	-	•
Test barrel geometry* : 3-Barrel					
2x 12 mm + 1x 15 mm / 3x 12 mm	-	•	•	•	•
2x 12 mm + 1x 15 mm / 3x 12 mm / 3x 15 mm / 3x 20 mm	-	-	-	-	•
Temperature range: +5°C higher than room temperature up to 400°C (option 500°C)	•	•	•	•	•
Temperature control algorithm, Display +/- 0.01 °C	•	•	•	•	•
Temperature control: 3x Pt100 sensor	•	•	•	•	•
5 Temperature calibration and control data set	•	•	•	•	•
Integrated timer for temperature set value	•	•	•	•	•
Servo drive, resolution 0.0000016 mm	0.000053 mm	•	•	•	•
Test piston speed range 0.00004 - 40 mm/s (0.0024 - 2400 mm/min)	0.0001 - 40 mm/s	•	•	•	•
Drive torque monitoring and display	•	•	•	•	•
Continuous variable control of test piston movement	•	•	•	•	•
Pressure transducers Accuracy of range	20-2000 bar 0.2%	20-2500 bar 0.2%			
Force transducers Accuracy class Accuracy (in range from 1% - 100%)	20 kN 0.02 0.4%	25 kN 0.02 0.4%	50 kN 0.02 0.4%	75 kN 0.02 0.4%	120 kN 0.02 0.4%
Maximum number of pressure/force transducers	5/2	5/2	5/2	5/3	5/3
Automatic identification of installed pressure transducers	•	•	•	•	•
Adaptive signal processing of pressure signal	+/- 0.005%				
Device integrated PC with 14.48 cm (5.7") Color-QVGA-Touchscreen	•	•	•	•	•
Microsoft Windows® data base Software "LabRheo" (script capable)	•	•	•	•	•
Measuring mode constant speed or pressure/ force	•	•	•	•	•
3 times overload detection	•	•	•	•	•
Power supply 3x 400 V, 3x 230 V, 50/60 Hz	1x 230 V, 50/60 Hz	•	•	•	•
Size (device) width x depth x height	850 x 635 x 1,550 mm	1,255 x 600 x 1,739 mm	1,255 x 600 x 1,739 mm	1,255 x 600 x 1,739 mm	1,255 x 600 x 1,739 mm
Size (table) width x depth x height	600 x 600 x 550 mm	790 x 600 x 620 mm	790 x 600 x 620 mm	790 x 700 x 620 mm	790 x 700 x 620 m
Weight	Approx. 270 kg	Approx. 450 kg	Approx. 480 kg	Approx. 630 kg	Approx. 650 kg
Add-On	Detection of flow instabilities (Shark-Skin), Thermal Conductivity, PVT, Die Swell, Pressure dependence of Viscosity (Counter Pressure Chamber)				
Options*	Melt Cutting Unit, Slit Die, RHEOTENS, HAUL-OFF, Thermocouple for determining the melt temperature, External tempering of the test chamber, Corrosion- and wear-resistant test barrel system, Nitrogen purge unit, Pneumatic or battery driven cleaning device				

* Further test barrel geometry, more applications and modifications on request.

THIS IS RHEOLOGY

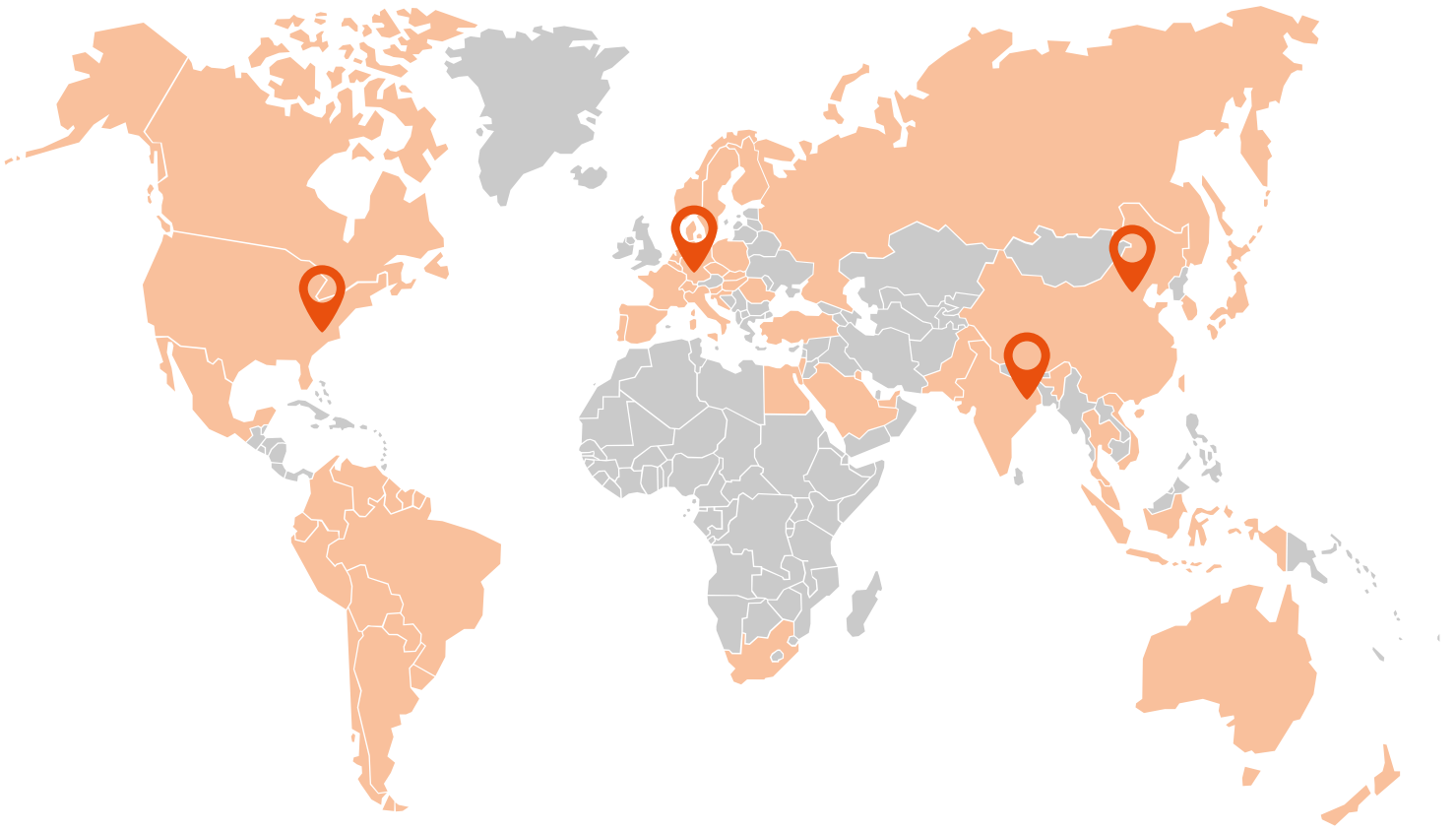

GÖTTFERT
THIS IS RHEOLOGY

**GÖTTFERT | Werkstoff-
Prüfmaschinen GmbH**

74722 Buchen

☎ +49 (0) 62 81 408-0

✉ info@goettfert.de

GOETTERT
THIS IS RHEOLOGY

GOETTERT Inc.

Rock Hill, SC 29730
USA

☎ +1 803 324 3883

✉ info@goettfert.com

GÖTTFERT
CHINA LIMITED

GOETTERT (China) Ltd.

Beijing 100027
CHINA

☎ +86-10-848 320 51

✉ info@goettfert-china.com

Gdi

GOETTERT | Dataphysics
Instruments India Pvt. Ltd.

Kolkata - 700 010 - INDIEN

☎ +91-9339867536

✉ info@gdinstruments.co.in