

CPN-214-142
Rev. A

Ultrasonic Cleaners
Models 1510, 2510, 3510, 5510, 8510



Operator's Manual



LAB Online Exhibition



Warranty

Ultrasonic Cleaners, when used in accordance with manufacturer's instructions and under normal use, are guaranteed for **two years after date of shipment**. Within the period guaranteed, manufacturer will repair or replace free of charge, at its sole discretion, all parts that are defective because of material or workmanship, not including costs for removing or installing parts.

Liability, whether based on warranty, negligence or other cause, arising out of and/or incidental to sale, use or operation of the transducer elements, or any part thereof, shall not in any case exceed the cost of repair or replacement of the defective equipment, and such repair or replacement shall be the exclusive remedy of the purchaser, and in no case will we be responsible for any and/or all consequential or incidental damages including without limitation, and/or all consequential damages arising out of commercial losses.

 **CAUTION** 

- Do not place parts or containers directly on the bottom of the cleaning tank; use a tray or wire to suspend items.
- Do not allow the solution to drop more than 3/8 inch below the operating level line with the cleaner on.
- Do not ever use alcohol, gasoline or flammable solutions. Doing so could cause a fire or explosion. Use only water-based solutions.
- Do not use mineral acids. These could damage the tank.

Contents

Front Cover	WARRANTY
1	Safety Precautions
3	Introduction
3	Ultrasonic Cleaners
4	Accessories
4	Unpacking Your Cleaner
4	Installing Your Cleaner
5	Equipment Specifications
6	How Ultrasonic Cleaning Works
7	Operating Your Cleaner
7	Operating Your MT or MTH Cleaner
10	Operating Your DTH Cleaner
14	Draining Your Cleaner
16	Optimizing Your Cleaner
18	Application Hints
19	Cleaning Methods
21	Cleaning Solutions
24	Troubleshooting
28	Service Information

Safety Precautions

Before using your Ultrasonic Cleaner, please read and thoroughly understand these safety precautions. Failure to follow them may result in serious personal injury or property damage.

To avoid electrical shock:

- Do unplug from power source before filling or emptying the tank.
- Do keep the control panel and the area around the cleaner clean and dry -- wipe up solution which spills over the tank brim. Water and high voltage can cause electrical shock.
- Do not operate the cleaner without proper grounding.
- Do not remove the grounding prong on the line cord plug.
- Do not disassemble your cleaner -- high voltage inside the cleaner is dangerous.
- Do not immerse the cleaner in water.

To prevent personal and/or property damage:

- Do operate the cleaner with a vented cover or no cover.
- Do use water-based solutions.
- Do not ever use alcohol, gasoline or flammable solutions. Doing so could cause a fire or explosion and will void your warranty. Use only water-based solutions.
- Do not ever use mineral acids. These could damage the tank.
- Do not touch the stainless steel tank or cleaning solution -- they may be hot.
- Do not allow fluid temperature to exceed 70°C (160°F).
- Do not place your fingers or hands into the tank while the cleaner is operating. Doing so may cause discomfort and possible skin irritation. Avoid contact with solutions and provide adequate ventilation.
- Do not use solutions containing chlorine bleach.

To prevent damage to the cleaner:

- Do change your solution regularly.
- Do not cover vents on the cover.
- Do not operate the cleaner dry.
- Do not place parts or containers directly on the bottom of the cleaning tank; use a tray or wire to suspend items. Failure to comply may cause transducer damage and will void your warranty.
- Do not allow the solution to drop more than 3/8 inch below the operating level line with heat or ultrasonics on. Failure to comply may cause transducer and/or heater damage and will void your warranty.

2 Safety Precautions

Introduction

Ultrasonic Cleaners

This line of ultrasonic cleaners include five models with sizes ranging from 1/2 gallons, 3/4 gallons, 1-1/2 gallons, 2-1/2 gallons and 5-1/2 gallons. Each model is constructed using durable industrial style 40kHz transducers. These provide increased cleaning power along with built in sweep frequency to ensure uniform cleaning activity throughout the bath. The 1/2 and 3/4 gallon models have a molded dip in their rims to facilitate emptying of solution from the tank. The three larger sizes have built in drains and are supplied with tank drain kits. Each model can be purchased in three different configurations -- with a Mechanical Timer (MT), with a Mechanical Timer plus Heat (MTH) and with Digital Control, plus Heat and Timer (DTH).

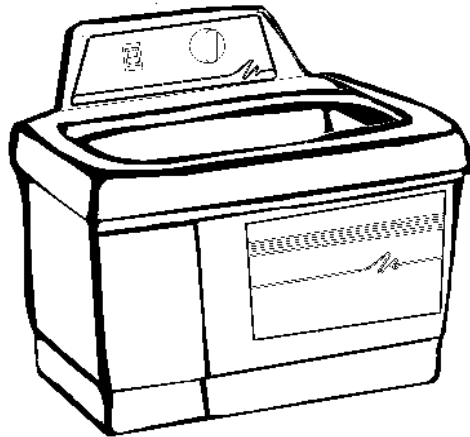

When you first fill your unit, or refill it with fresh solution, use warm water for the solution. Turn on the heater (press the HEAT switch, if available), turn on the ultrasonics (press SONICS or rotate the Timer knob), add the cover and the solution will heat quickly to temperature.

Accessories For Your Cleaner

Accessories include regular and beaker positioning covers, solid and perforated insert trays, mesh baskets and beakers.

Unpacking Your Cleaner

Please check your cleaner and its carton carefully for any external or internal damage. **If you find damage, contact your shipping carrier immediately**, before contacting your distributor. Please retain your packaging for future use.

Installing Your Cleaner

Check the plate on the back of the cleaner for correct power requirements. Position your cleaner within easy reach of a standard grounded electrical outlet. Do not place the cleaner on a circuit which could become overloaded.

If your cleaner does not operate correctly, first refer to the troubleshooting section for possible causes, or contact an authorized service center listed at the back of this manual, for additional information.

Equipment Specifications

Tank Capacity	Tank Size	Overall Size	Weight	Max Input Power	Heater Power	Max. Draw Power Req. (Watts)*
1/2 gal. (1.91 L)	L: 6" W: 5.5" D: 4"	L: 10" W: 12" D: 11.5"	7 lbs. (3.2KG)	80W	0 63 63	80 143 143
3/4 gal. (2.81 L)	L: 9.5" W: 5.5" D: 4"	L: 13.5" W: 12" D: 11.5"	9 lbs. (4. KG)	130W	0 109 109	130 239 239
1-1/2 gal. (5.71 L)	L: 11.5" W: 6" D: 6"	L: 16" W: 12" D: 14.5"	12 lbs. (5.4 KG)	130W	0 205 205	130 335 335
2-1/2 gal. (9.51 L)	L: 11.5" W: 9.5" D: 6"	L: 16" W: 15.5" D: 14.5"	14 lbs. (6.4 KG)	185W	0 284 284	185 469 469
5-1/2 gal. (20.81 L)	L: 19.5" W: 11.5" D: 6"	L: 24" W: 18" D: 14.5"	26 lbs. (11.8 KG)	320W	0 561 561	320 881 881

NOTE:

- All models have a frequency of 40kHz.
- In DTH cleaners, the temperature readout accuracy is $\pm 4^{\circ}\text{C}$.
- 120V $\pm 10\%$, 60Hz is optimum voltage for all cleaners.
- All cleaners have CSA approval and comply with FCC regulations.
- All 220V units meet CE standards.
- * indicates power levels for MT, MTH and DTH cleaners, in that order.
- Units will cause GFI sockets to trip.
- All units have a ground leakage current less than .50ma.

How Ultrasonics Cleaning Works

Ultrasonic sound is sound transmitted at frequencies generally beyond the range of human hearing. In your ultrasonic cleaner, ultrasonic sound (sonics) is used for cleaning materials and parts. This is how it works:

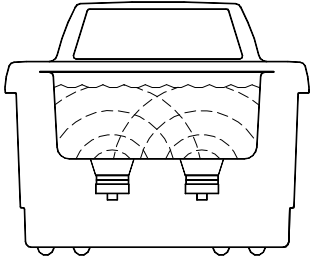

- As the sound waves from the transducer radiate through the solution in the tank, they cause alternating high and low pressures in the solution.

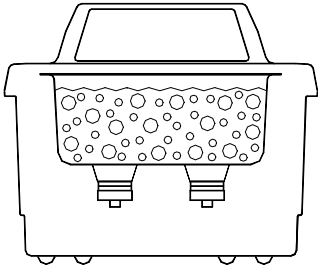

- During the low pressure stage, millions of microscopic bubbles form and grow. This process is called CAVITATION, meaning “formation of cavities”.

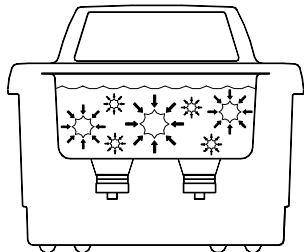

- During the high pressure stage, the bubbles collapse, or “implode” releasing enormous amounts of energy. These implosions act like an army of tiny scrub brushes. They work in all directions, attacking every surface and invading all recesses and openings.

Operating Your Cleaner

If this is the first time you are using the cleaner, please read this whole section before operating your cleaner.

Operating Your MT or MTH Cleaner

MT Cleaner

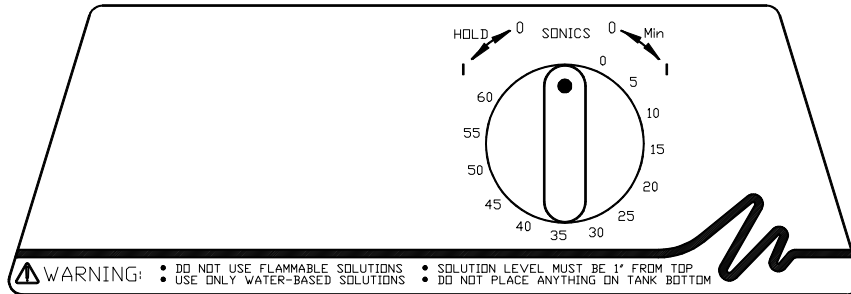

MTH Cleaner

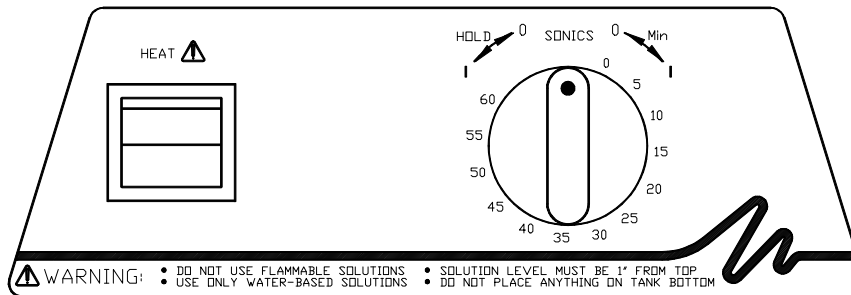

Explanation of Controls

Control	Function
HEAT (MTH only)	Activates heat to 60°C maximum. NOTE: Refer to pages 16 and 17 for further temperature information.
TIMER	Activates ultrasonics and sets time. Use to turn unit Off.
	Turn clockwise for variable time 0-60 mins. Turn counterclockwise to hold position for continuous operation.

7 Operating Your Cleaner

Before You Start Cleaning



- Do not place parts or containers directly on the bottom of the cleaning tanks; use a tray or wire to suspend items.
- Do not allow the solution to drop more than 3/8 inch below the operating level line with the cleaner on.
- Do not ever use alcohol, gasoline or flammable solutions. Doing so could cause a fire or explosion. Use only water-based solutions.
- Do not ever use mineral acids. These could damage the tank.

Failure to comply with these cautions will void your warranty.

Step	Action
1	Select your cleaning solution (refer to page 23 for solution effects on metals).
2	Allowing for the volume of the parts you will be cleaning and cleaning solution, fill the tank with warm tap water to the operating level line (one inch from the top).
3	Add cleaning solution to the tank water.
4	Plug the cleaner into a grounded outlet.
5	For maximum efficiency, refer to page 16, "Optimizing Your Cleaner" before proceeding.

NOTE:

If this is the first time you are running the cleaner, or if you have changed cleaning solution, you must degas the solution. If not, skip to "**Cleaning Items**".

Degassing

Step	Action
1	Turn the HEAT ON (MTH Cleaner only).
2	Turn the TIMER to 5-10 and let the cleaner run to allow the solution to “degas”. NOTE: Refer to page 17 for information on degassing.

Cleaning Items

NOTE: To stop ultrasonics at any time, turn the TIMER to zero.

Step	Action
1	Set the TIMER for the amount of time you wish the items to be cleaned.
2	Place the items into a basket, perforated tray, or beakers in a positioning cover.
3	If using beakers or a solid tray, add cleaning solution to beakers or tray to cover the items.
4	Slowly lower the tray or beakers into the tank. Do not allow items to contact the tank bottom. Do not stir the solution.
5	When items are clean, slowly remove them from the cleaner.
6	Rinse the clean items with clean water and dry them, if necessary.

Operating Your DTH Cleaner

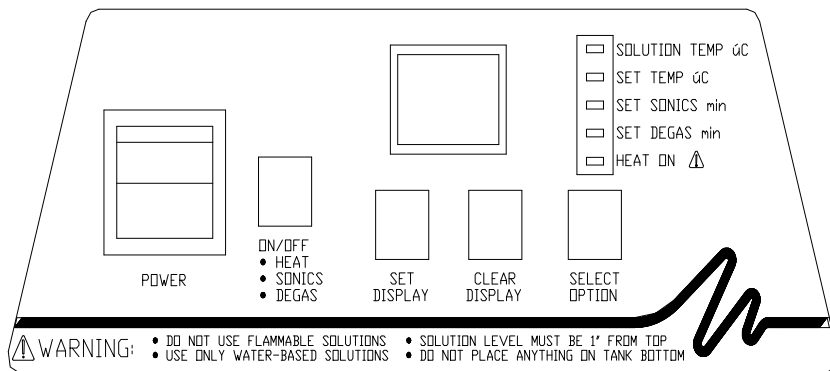

Explanation of Controls

Control	Function
POWER	Press to activate/deactivate power to the cleaner.
ON/OFF	After you press SELECT OPTION and set the LED Display for the selected option, press to activate HEAT (SET TEMP), SONICS (SET SONICS) and/or DEGAS (SET DEGAS).
LED Display	Indicates the tank temperature, set temperature, ultrasonics time or degas time setting, depending on your SELECT OPTION choice.
SET/ CLEAR DISPLAY	Used in conjunction with SELECT OPTION to set or clear the LED display. Press CLEAR DISPLAY to clear the LED display to 00. Press SET DISPLAY to reach your selection.
SELECT OPTION	When pressed, toggles through the Function Indicators. This allows you to check or set the tank temperature and set ultrasonic cleaning or degas time.

Continued...

Control	Function
Function Indicators	Lights indicate the option selected by pressing SELECT OPTION. SOLUTION TEMP: Displays current solution temp. (10 - 75°C, ± 4°C). SET TEMP: Set tank temperature (01 - 69°C). SET SONICS: Set ultrasonic time (01 - 99 mins., 60 mins. default). SET DEGAS: Set degas time (01 - 99 mins., 5 mins. default). HEAT ONE: Indicates heat is activated and has been set (SET TEMP).

Before You Start Cleaning

Step	Action
1	Select your cleaning solution.
2	Allowing for the volume of the parts you will be cleaning and for the cleaning solution, fill the tank to the operating level line (one inch from the top) with warm tap water.
3	Add a cleaning agent to the tank water.
4	Plug the cleaner into a grounded outlet.
5	Turn the POWER switch On. The cleaner will run through a three-second self-test. Wait until the LED Display shows 05 and the SET DEGAS Function Indicator lights.

NOTE:

If this is the first time you are running the cleaner, or if you have changed cleaning solution, you must degas the solution. If not, move to *Setting Operating Parameters*.

Degassing

Step	Action
1	Degas for 5-10 minutes. If necessary, use SET/CLEAR DISPLAY to alter this setting. Default degas time is 5 minutes. NOTE: Refer to page 17 for information on degassing.
2	Press ON/OFF once to start the degas process.
3	After completing the degas time, you are ready to set operating parameters.

Setting Operating Parameters

Step	Parameter	Action
1	Set Time	The cleaner is now in Set Time mode with a default time of 60 mins. If necessary, use SET/CLEAR DISPLAY to alter this setting. Press ON/OFF once to activate timed ultrasonics.
2	Set Temp.	To set the tank temperature, press SELECT OPTION until the SET TEMP LED lights. Then press SET DISPLAY to alter the setting until the LED display indicates the tank temperature you wish to maintain. Press ON/OFF once to activate heat. The heat indicator lights.
3	Solution Temp.	To monitor the solution temperature, press SELECT OPTION until the SOLUTION TEMP LED lights. The LED display will indicate the actual temperature of the solution.

Cleaning Items



- Do not place parts or containers directly on the bottom of the cleaning tank; use a tray or wire to suspend items.
- Do not allow the solution to drop more than 3/8 inch below the operating level line with the cleaner on.
- Do not ever use alcohol, gasoline or flammable solutions. Doing so could cause a fire or explosion. Use only water-based solutions.
- Do not ever use mineral acids. These could damage the tank.

Failure to comply with these cautions will void your warranty.

NOTE: Select Set Time then press ON/OFF once to stop ultrasonics at any time.

Step	Action
1	Place the items into a basket, perforated tray, or beakers in a positioning cover.
2	If using beakers or a solid tray, add cleaning solution to beakers or tray to cover the items.
3	Slowly lower the tray or beakers into the tank. Do not stir.
4	Press ON/OFF once to activate ultrasonics.
5	When the items are clean, press ON/OFF once to deactivate ultrasonics, then slowly remove the items from the cleaner.
6	Rinse clean items with clean, warm water and dry, if necessary.

- **To repeat a timed cleaning cycle** - press ON/OFF once while in the Set Sonics mode. This cleaning cycle time will remain in memory until reset or you turn off the power to the cleaner.
- **To reset ultrasonics time during a cleaning cycle** - press ON/OFF once, press SELECT OPTION until the SET SONICS LED lights. To increase time, press SET DISPLAY to your desired setting. To decrease time, press CLEAR DISPLAY, press SET DISPLAY to set the time, then press ON/OFF once to resume the cycle.
- **To monitor the solution temperature** - press SELECT OPTION until the SOLUTION TEMP LED lights. The LED Display will display the solution temperature in degrees Centigrade ($\pm 4^{\circ}\text{C}$). The cycle will continue during this process.

Draining Your Cleaner

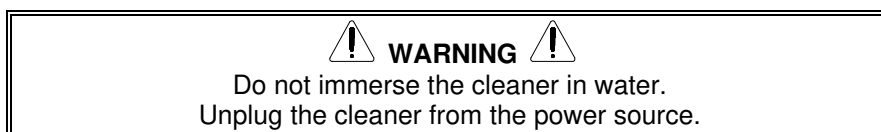

1/2 and 3/4 gallon models do not have a drain. To empty, use the indented side of the rim to pour the used solution into a waste disposal unit, rinse the tank thoroughly and refill with new solution.

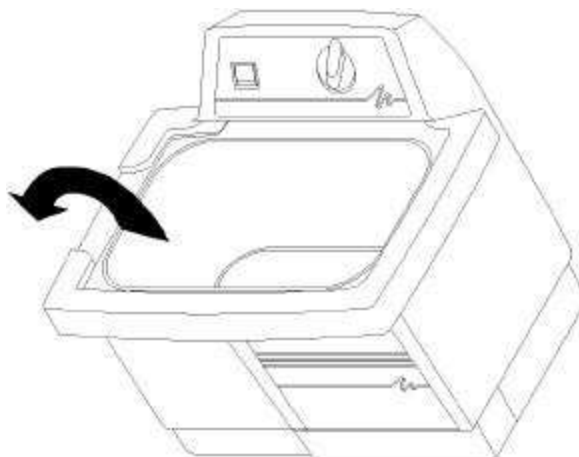

1-1/2, 2-1/2 and 5-1/2 gallon models include a drain and valve kit.

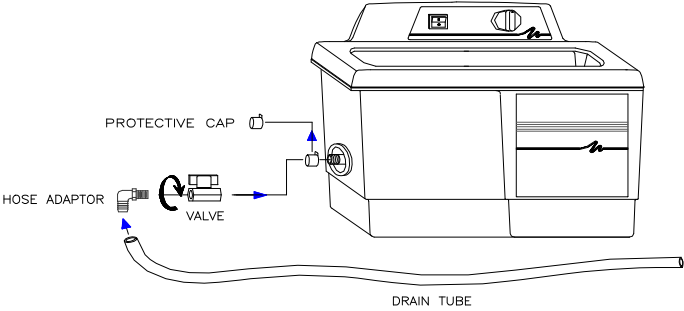
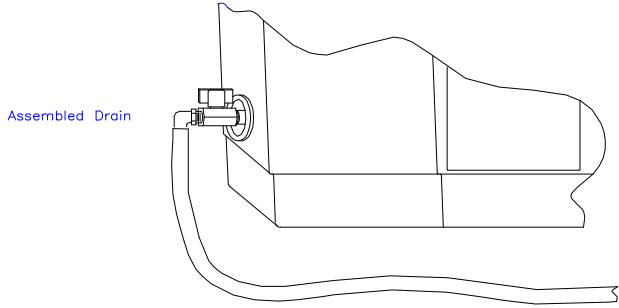
Step	Action
1	Place the cleaner to allow easy reach of the drain tube into a waste disposal unit.
2	Remove the thread protecting cap from the end of the cleaner's drain pipe. This will expose the white teflon sealing tape on the drain pipe's threads.
3	<p>Hand tighten the drain valve onto the drain pipe over the white teflon sealing tape. Finish tightening the valve in place using an adjustable or a 21mm wrench. Tighten the valve no more than one full turn when using the wrench until the handle is on top.</p> <p>CAUTION: Over tightening of the valve can cause damage to the ultrasonic tank. Always use teflon sealing tape or a sealing paste designed for use with stainless steel if retightening or refitting of the drain valve is required.</p> 
4	<p>Hand tighten the hose adaptor into the end of the drain valve. Slide the drain tube over the barbed hose adaptor end.</p> 
5	Close the drain valve by turning the handle perpendicular to the valve body and the cleaner is ready to fill with solution. To open the valve and drain the cleaner, turn the handle so that it is in line with the valve body.

15 Operating Your Cleaner

Optimizing Your Cleaner

Tanks

Cleaning - check the tank for contamination whenever you change solution. If necessary, remove contaminants with a nonabrasive cloth and water.

Emptying - always unplug the cleaner before emptying the tank. Empty the solution into a waste disposal unit.

Filling - always unplug the line cord before filling the tank. Fill the cleaner to the operating level (one inch from the top with beaker/tray in place), using warm tap water.

Low solution level - will cause the cleaner to fail. When you remove heavy or bulky loads from the cleaner, the solution level may drop below the operating level. If so, be sure to replace lost solution and degas, if necessary, depending on the amount used.

Overload - do not rest any items on the tank bottom. Weight on the tank bottom dampens sound energy and will cause damage to the transducer. Instead, use a tray and/or beaker positioning cover to support all items. Allow at least one inch between the tank bottom and the beaker or receptacle for adequate cavitation.

Covers - allow the cleaner to heat up faster, to a higher temperature, and avoid excessive liquid evaporation. However, obstructing the cover vents will cause the cleaner to overheat.

Temperature

Heater - the heater may cause some discoloration of the tank wall. This is normal and will not affect the performance of the unit.

Solution - the fastest method to heat your cleaner is to fill with warm solution, use heat, ultrasonics (which also adds heat), and a cover.

Approximate stabilization temperatures with ultrasonics and heat running continuously:

MTH/DTH cleaner without a cover 50°
MTH/DTH cleaner with a cover 62°

continued...

Over temperature protection (DTH only) - the cleaner will shut down at 75°C and the LED display will blink "75". Turn the cleaner off and allow it to cool down. For a faster cooldown, replace some of the warm solution with cold solution.

Solution

Solution activity - the amount of visible activity is not necessarily related to optimum cavitation for cleaning.

Degassing - fresh solutions contain many dissolved gases (usually air), which reduce effective ultrasonic action. Although solutions will naturally degas over time, using Degas mode speeds up the degassing process. Solutions that have been sitting unused for 24 hours or longer have reabsorbed some gases.

Heat - increases the chemical activity of cleaning solutions.

Surface tension - can be reduced by adding solution to the bath. Reduced surface tension will increase cavitation intensity and enhance cleaning.

Solvents - never use solvents. Vapors of flammable solutions will collect under the cleaner, where ignition is possible from electrical components.

Renewal - replace cleaning solutions often to increase ultrasonic cleaning activity. Solutions, as with most chemicals, will become depleted over time. Solutions can become contaminated with suspended soil particles which coat the tank bottom, inhibiting ultrasonic activity.

Application Hints



- Never clean *novelty or inexpensive jewelry* in the cleaner. The combination of heat and vibration may loosen a cement-held setting.
- Never clean *gemstones* such as emerald, amethyst, pearl, opal, coral, turquoise, peridot or lapis lazuli in the cleaner.

First time cleaning - first experiment with one piece, then proceed with the remainder.

Solution level - Be sure to maintain solution level within 3/8 inch of the tank's "operating level" line. Surface activity can vary with liquid level.

Load size - It is faster and more efficient to run several small loads rather than a few big loads.

Placing items - Never allow items to sit on the bottom of the tank. Always place them in a tray or beaker or suspend in the solution.

Rinsing items - After cleaning, use a clean water bath to rinse away chemicals adhering to items.

Lubricating items - When necessary, re-lubricate items immediately after cleaning.

Drying items - Air drying at room temperature works for some items. Place parts requiring faster drying time under hot air blowers or in ovens.

Please call your local distributor if you have application questions.

Cleaning Methods

There are two methods of cleaning - direct and indirect. Each has advantages and disadvantages. When in doubt, run test samples using both methods to decide which one produces the best results for you.

Direct Method

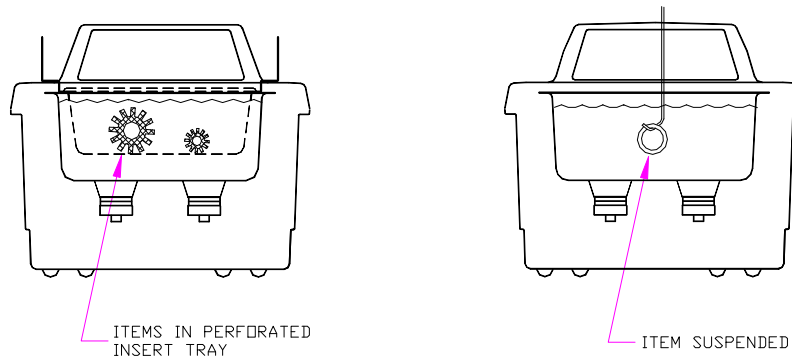

How it works:

- Fill the tank with warm water and a cleaning solution.
- Place the items to be cleaned in a perforated tray and lower them into the tank. You can also suspend items on a wire and then immerse them in the solution.

The advantages of this method are the simplicity of operation and cleaning effectiveness.

Indirect Method

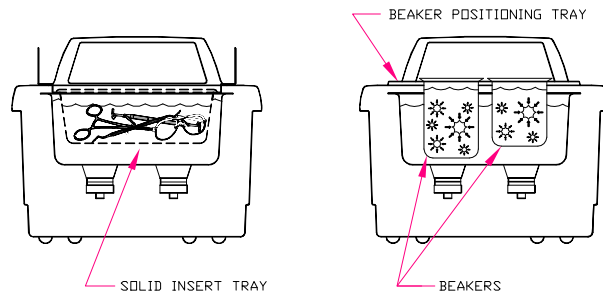

How it works:

- Fill the tank with warm water and a cleaning solution.
- Pour your solution medium into one or more beakers or into a solid insert tray.
- Place the beakers in a beaker positioning cover or a solid insert tray to fit your cleaner. Beakers should not touch the tank's bottom.

The advantages of this method are:

- Removed soil stays in the beaker or tray so you can easily examine, filter or discard it.
- You can use one or more solutions at the same time.
 - two completely different cleaning solutions.
 - one beaker or tray with a cleaning solution and one with a rinse solution.
- Cleaning solution in your tank needs to be changed less often.

Cleaning Solutions



Do not use alcohol, gasoline, bleach, mineral acids, solutions with a flash point, semi-aqueous or combustible liquids in ultrasonic tanks, or you will void the warranty. Only use non-flammable solutions and water-based solutions.

Solution Types

Water-based solutions are either slightly acidic or alkaline. They include detergents, soaps and industrial cleaners designed to remove specific soils.

Acidic water-based solutions: remove rust, tarnish or scale. They range from mild solutions that remove tarnish, to concentrated, inhibited acidic solutions that remove investment plaster, milk-stone, zinc oxide and rust from steel and cast iron as well as smut and heat-treat scale from hardened steel.

Alkaline water-based solutions: include carbonates, silicates and caustics. These cause emulsifying action, which keeps soil from redepositing on the cleaned surface, and improves cleaning action in hard water.

Alkaline strength	Removes:
Mild	Light oils and greases, cutting oils and coolant compounds.
Mild to strong	Heavy grease and oil, waxes, vegetable oils, inks, wax or fat-base buffing and polishing compounds, milk residues and carbohydrates.
Heavy-duty	Mill scale, heat-treat scale, corrosion or oxides.

Change the cleaning solution periodically. Cleaning solutions can become contaminated with suspended soil particles which coat the tank bottom. This coating dampens the ultrasonic action and reduces cleaning efficiency. Certain solutions will cavitate better than others. Contact your local distributor for further information.

Heat and cavitation: increase the chemical activity of cleaning solutions. Some materials may be damaged by this stronger chemical action. When in doubt, test run samples of items to be cleaned.

Caustic solutions: used to remove rust from steels, metal alloy corrosion and a variety of tenacious soils.

Solution Amounts

Solution amounts may vary. The amount you use depends on the detergent and the type of soil to be removed. Follow instructions on the solution container and refer to the table below for the effects of solutions on metals.

Chemicals Harmful to Your Tank

The following chemicals will harm your ultrasonic tank and the action of ultrasonics and higher operating temperatures will increase their chemical activity. Do not use these or similar chemicals directly or in dilution in your ultrasonic tank or you will void your warranty.

Acetophenone	Chloracetic Acid	Hydrocyanic Acid
Aluminum Chloride	Chloric Acid	Hydrofluoric Acid
Aluminum Fluoride	Chlorine, Anhydrous	Hydrofluosilicic Acid
Aluminum Sulphate	Chromic Acid	Iodoform
Ammonium Bifluoride	Copper Chloride	Mercuric Chloride
Ammonium Chloride	Copper Fluoborate	Muriatic Acid
Ammonium Hydroxide	Ethyl Chloride	Phosphoric (crude)
Amyl Chloride	Ferric Chloride	Sodium Hypochlorite
Antimony Trichloride	Ferrous Chloride	Potassium Chloride
Aqua Regia	Ferris Sulfate	Stannic Chloride
Bromine	Fluoboric Acid	Stannous Chloride
Calcium Bisulfate	Fluorine	Sulfur chloride
Calcium Bisulfite	Hydrobromic Acid	Sulfuric Acid
Calcium Hypochloride	Hydrochloric Acid	Zinc Chloride

Solution Effects on Metals

Cleaning Agent	Steel	Brass	Aluminum	Magnesium	Zinc	S. Steel Copper	Tin
Optical (1)	none	none	none	none**	none**	none	none**
Jewelry (1)	none	none	none	none	none	none	none
Buffing (1) compound	none	slight stain	none	none	attacks	none	none
Oxide (2) remover	slight etch	none	slight attack	attacks	attacks	none	none
Electronic cleaner (1)	none	none	slight attack	none	none	none	none
General(1) purpose	none	none	slight attack	none	none	none	none
Industrial strength(1)	none	none	slight attack	none	none	none	none
Metal (1) cleaner 1	none	none	none	none	none	none	none
Metal (1) cleaner 2	none	none	slight attack	none	none	none	none
Metal (1) cleaner 3	none	none	none	none	none	none	none
Rust (3) stripper	none	none	attacks	attacks	attacks	none	slight attack

(1) = Alkaline; (2) = Acidic; and (3) = Caustic.

 WARNING 
<p>*Free hydrogen may be released if solution comes in contact with reactive metals.</p>

** No effect if solution temperature is less than 140°F.

Troubleshooting

If your cleaner does not operate satisfactorily, please check the tables below for possible causes before calling your authorized service center.

 **WARNING** 
High voltage inside - dangerous shock hazard.
DO NOT attempt to disassemble or repair the cleaner.

Problem	Cause	What to do
Cleaner will not start.	Cleaner not plugged in properly. MT - Mechanical timer not ON. DTH - POWER switch not ON. DTH - Start button malfunctioning. Blown fuse.	Plug into functioning electrical outlet. Turn timer clockwise. Press power switch ON. Call nearest authorized service center. Call nearest authorized service center.
Cleaner operates but does not heat solution	Heater malfunctions. MTH - HEAT not ON. DTH - HEAT not set properly. DTH - membrane malfunctioning.	Call nearest authorized service center. Turn heat ON See <i>Operating Your DTH Cleaner</i> . Call nearest authorized service center.
Clogged drain	Clogged drain.	Call nearest authorized service center.



WARNING

**High voltage inside - dangerous shock hazard.
DO NOT attempt to disassemble or repair the cleaner.**

Problem	Cause	What to do
Cleaner operates but does not maintain set temperature	Malfunctioning heater or sensor components.	Call nearest authorized service center.
Cleaner operates but display does not function.	Interrupted calibration sequence. DTH - timer board malfunctioning.	Press SET DISPLAY Call nearest authorized service center.
Cleaner stops operating and display blinks "75".	Overheat condition.	Turn cleaner off. Allow cleaner to cool, check solution level, then restart. Refer to <i>Optimizing Your Cleaner</i> .
Decreased ultrasonic activity. NOTE: Refer to page 27 for cavitation check.	Solution is not degassed. Solution is spent. Solution level is incorrect for load. Tank bottom is covered with soil particles. Using deionized water in the tank.	Make sure that tank was filled with warm tap water plus cleaning solution and has run 5-10 minutes. Change solution. Adjust solution to within 3/8 inch of the tank's operating level line with load. Empty, then clean tank with warm water. Wipe with a nonabrasive cloth. Deionized water does not cavitate as actively as soapy tap water.

Check your cleaner periodically to test the level of activity of the ultrasonic cavitation. Frequency of testing will depend on your use of the cleaner.

Glass Slide Test

You will need the following equipment:

- Frosted microscope glass slide (1" x 3"), such as ESCO #2951F, or equivalent;
- No. 2 lead pencil; and
- General purpose household cleaning solution, such as "Dawn" liquid soap.

Test procedure:

1. Prepare a fresh solution with general purpose household cleaning solution (concentration 1%) and warm tap water (120° - 140°F).
2. Fill the cleaner to within 3/8 inch of the "operating level" line.
3. Turn the ultrasonics on for at least five to ten minutes to allow for degassing.
4. Prepare the glass slide by first wetting the frosted portion with tap water.

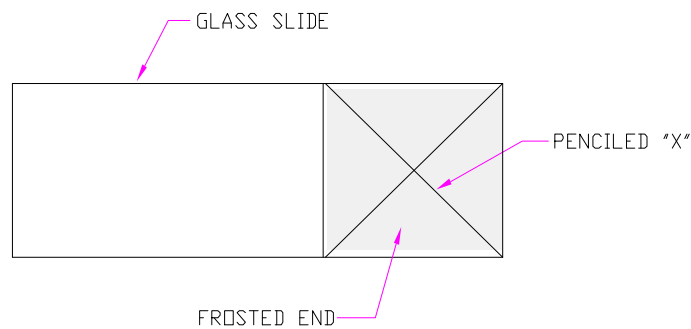

5. With the No. 2 pencil, on the frosted portion make an "X" from corner to corner.
6. Immerse the frosted end of the slide into the solution. Hold the slide vertically and center it in the solution.
7. Make sure that model DTH cleaners are in SET SONICS mode, not degas mode, then turn ultrasonics On.

The ultrasonics will begin immediately to remove the lead from the slide. All lead should be removed within 10 seconds. If your cleaner passes this test, its ultrasonic cavitation is acceptable.

NOTE:

To ensure consistency from test to test, be sure to repeat test conditions - use the same solution concentration, liquid level, temperature, type of pencil, length of degassing, etc.

Service Information

With normal use, your Ultrasonic Cleaner should not require servicing. However, if it fails to operate satisfactorily, first try to diagnose the problem by following the suggestions in the Troubleshooting Guide.



You will void the warranty if you disassemble your cleaner. High voltage inside the cleaner is dangerous.

If you find that your cleaner needs repair, carefully pack and return it to your local distributor. If under warranty, remember to include proof of purchase.

Your cleaner will be shipped by ground service unless you specify otherwise.

Authorized Service Centers

Name	Address	Tel/Fax Number
Alpha Omega Electronics Corp.	2821 National Drive Garland, TX 75041	Tel: 972-271-5569 Tel: 1-800-540-4967 Fax: 972-840-3668
Crystal Electronic Inc.	140 Centre Street Aurora Canada L4G 1K0	Tel: 905-841-5762 Fax: 905-841-9688
Paragon Electronics	11075 N.E. 6th Ave. Miami, FL 33161	Tel: 305-757-0631 Fax: 305-754-6877
Master Sonics Repair Center	445 West Queen St. Southington, CT 06489	Tel: 800-737-2198 860-621-9466 Fax: 860-621-0283

Authorized Service Centers

Notes:

Technical Support:

Branson Ultrasonics Corp.	41 Eagle Road P.O. Box 1961 Danbury, CT 06813-1961	Tel: 203-796-0339 Tel: 203-796-0557 Fax: 203-796-2240
---------------------------	--	---